

Rellena con pintura de dedos las pelotas grandes.

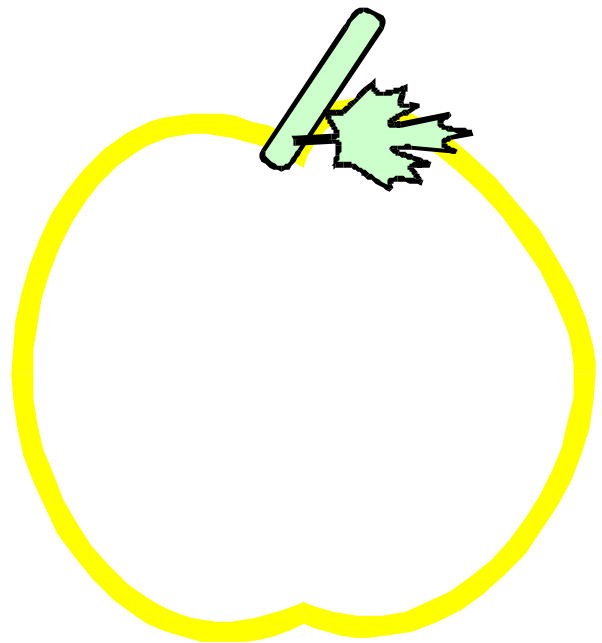

Rellena con papeles rojos la manzana grande y pinta de amarillo la manzana pequeña.

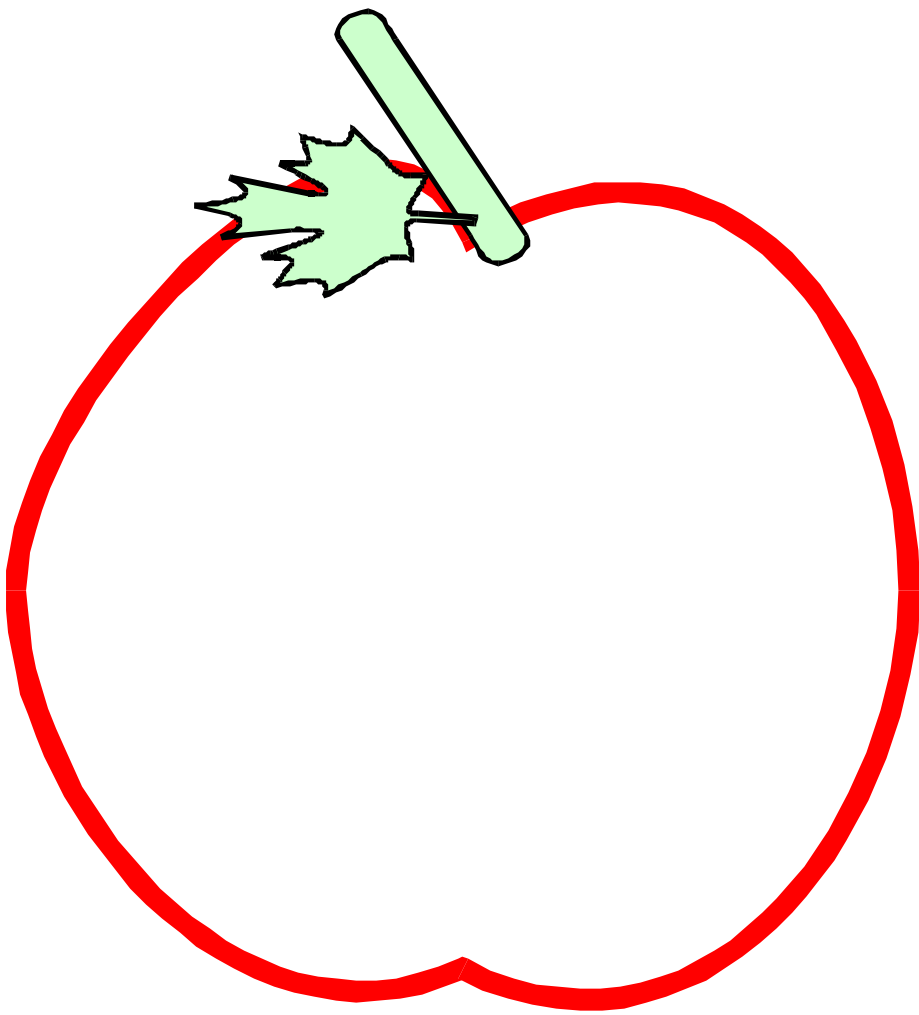
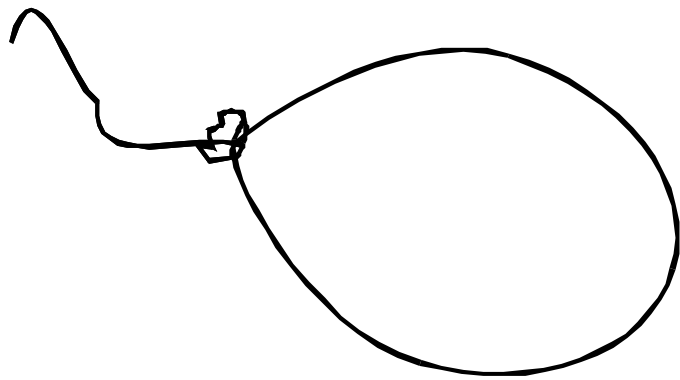
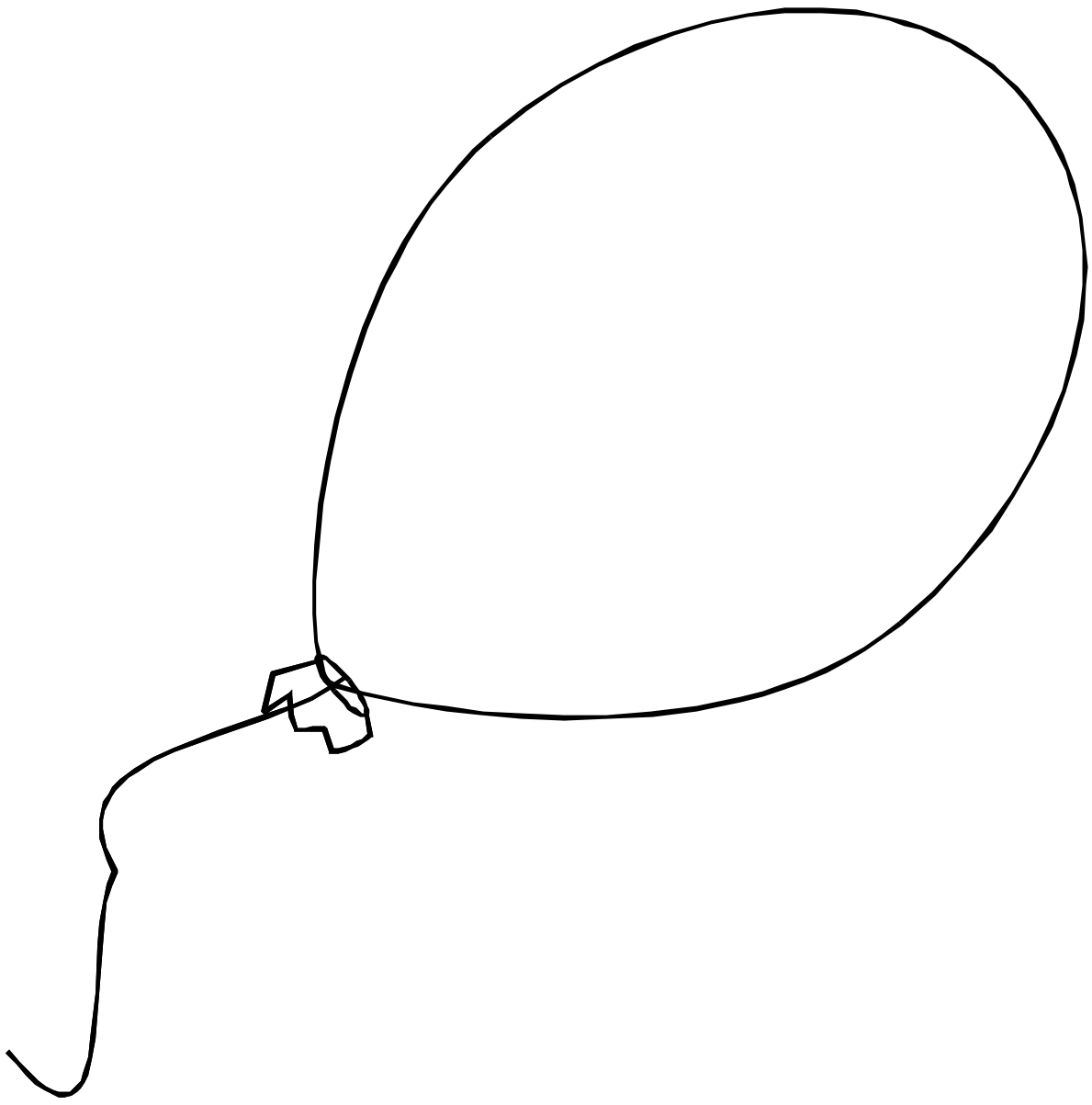

Pinta de amarillo el globo grande.

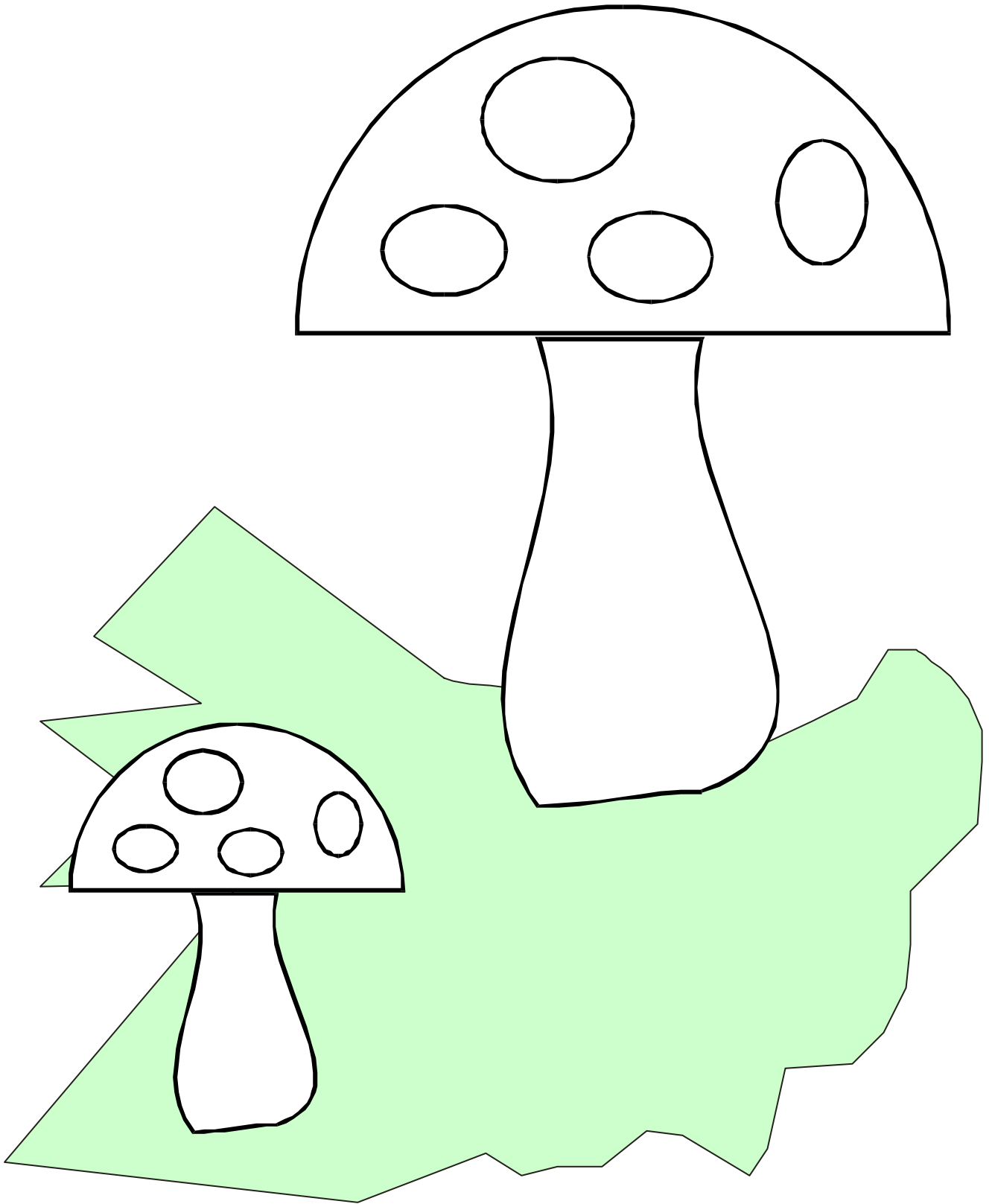

Pinta la seta grande

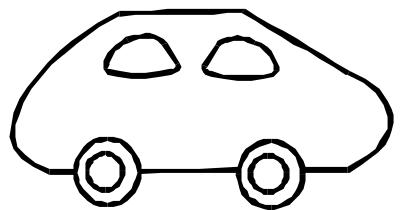
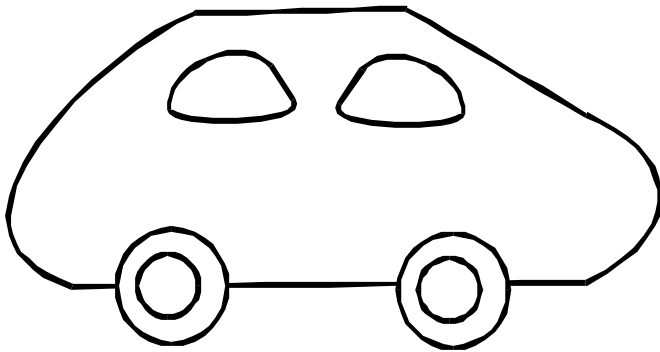
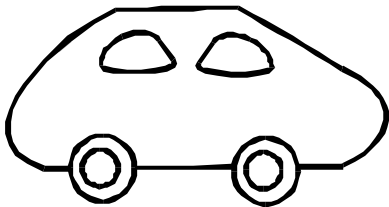
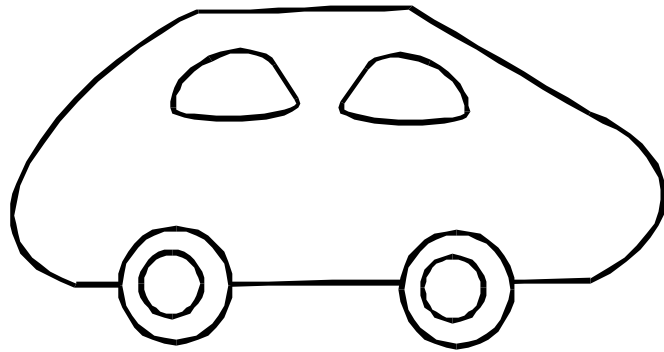
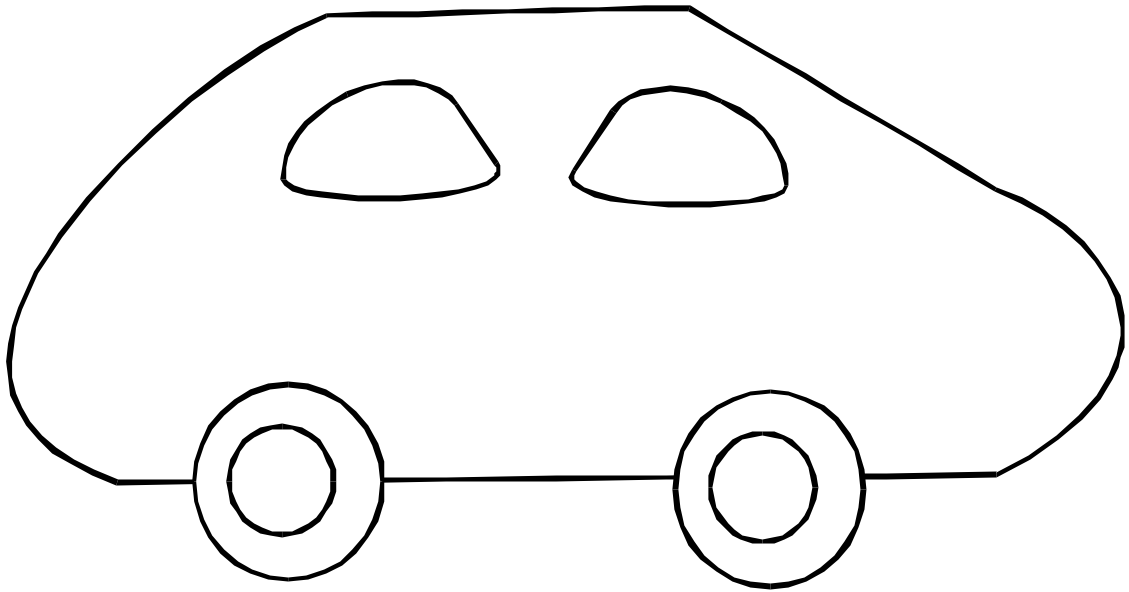

Pinta los coches medianos.

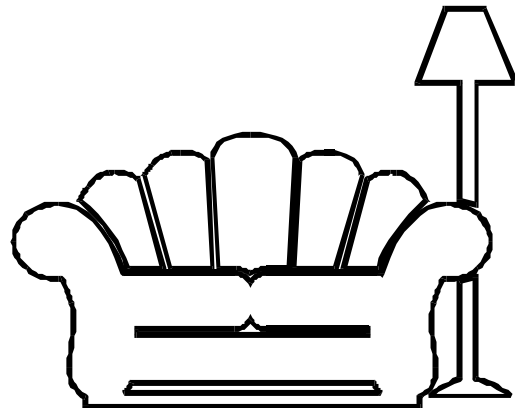
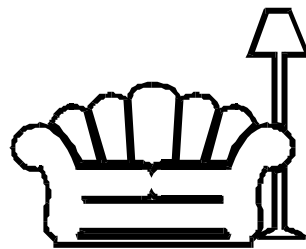
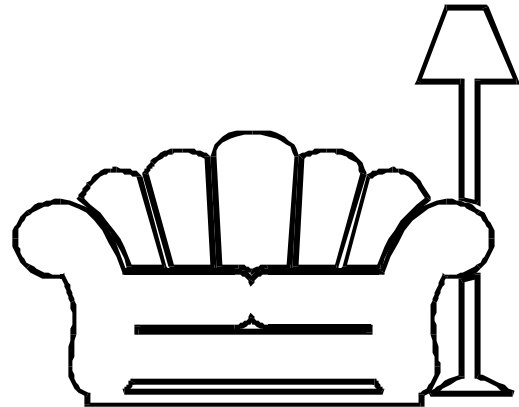
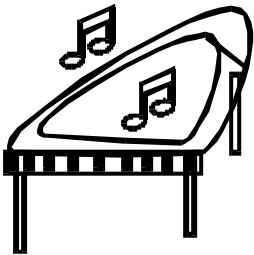
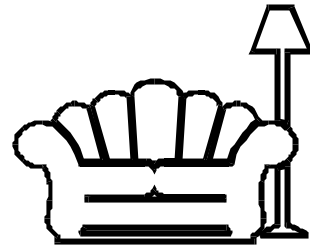
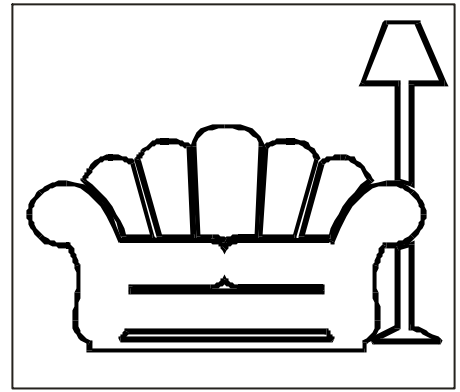
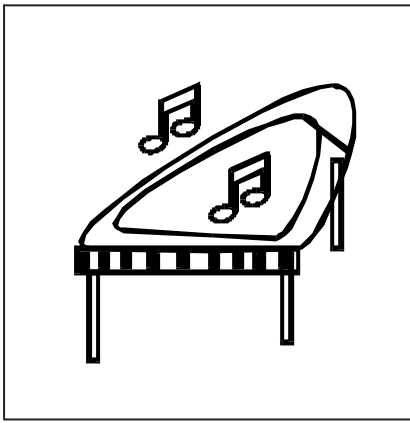

Pinta los pianos más pequeños y los sofás más grandes que el modelo.

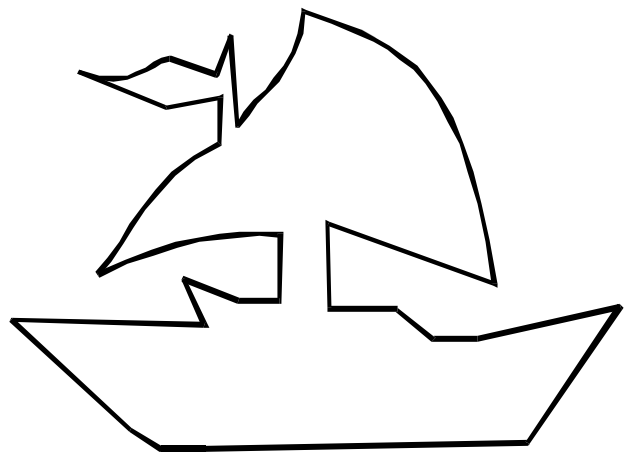
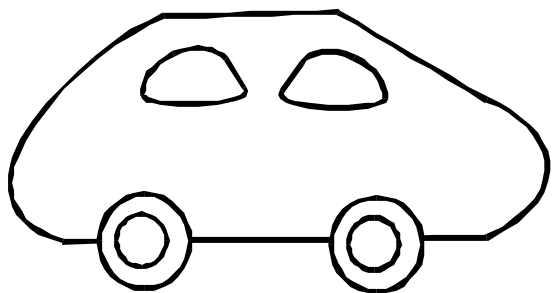
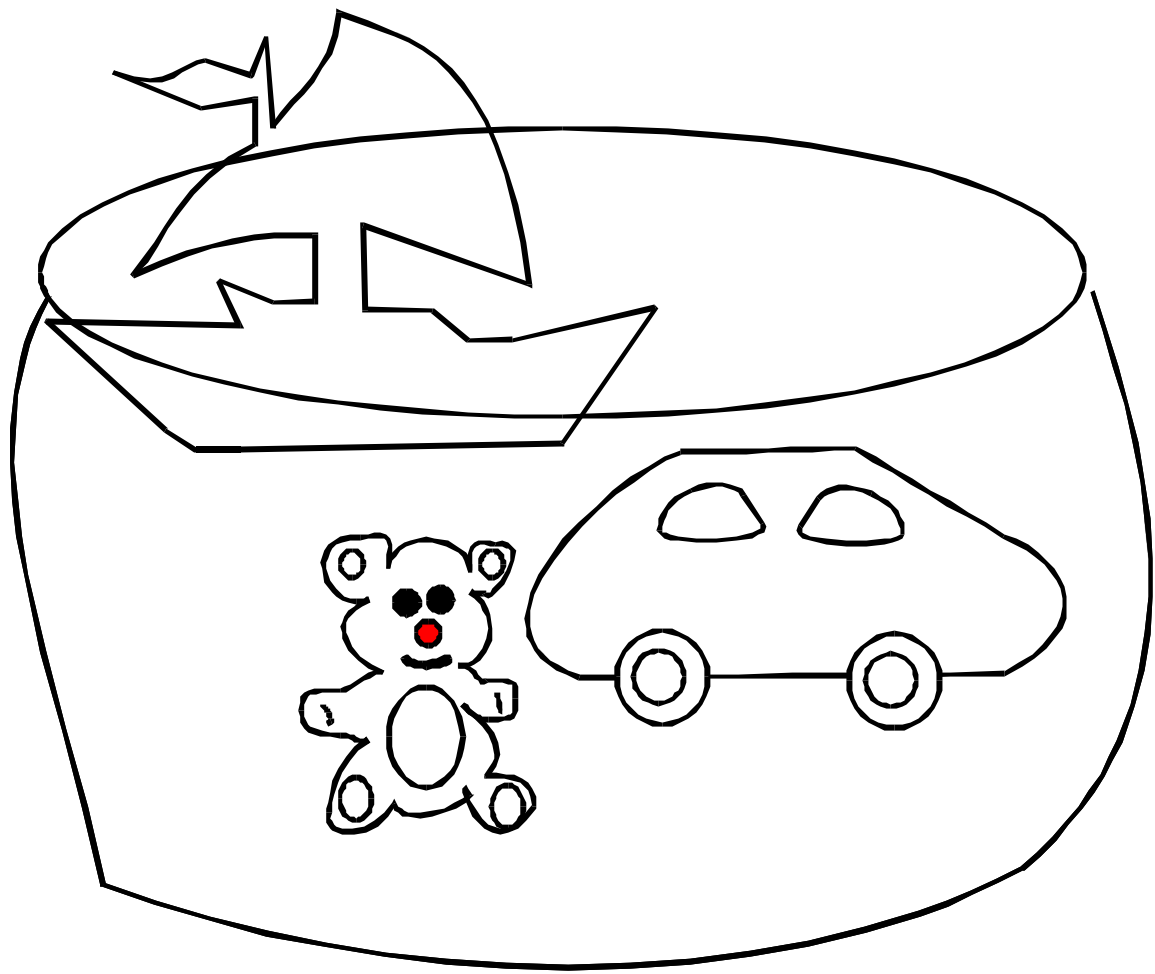

Pinta los juguetes que están fuera de la caja.

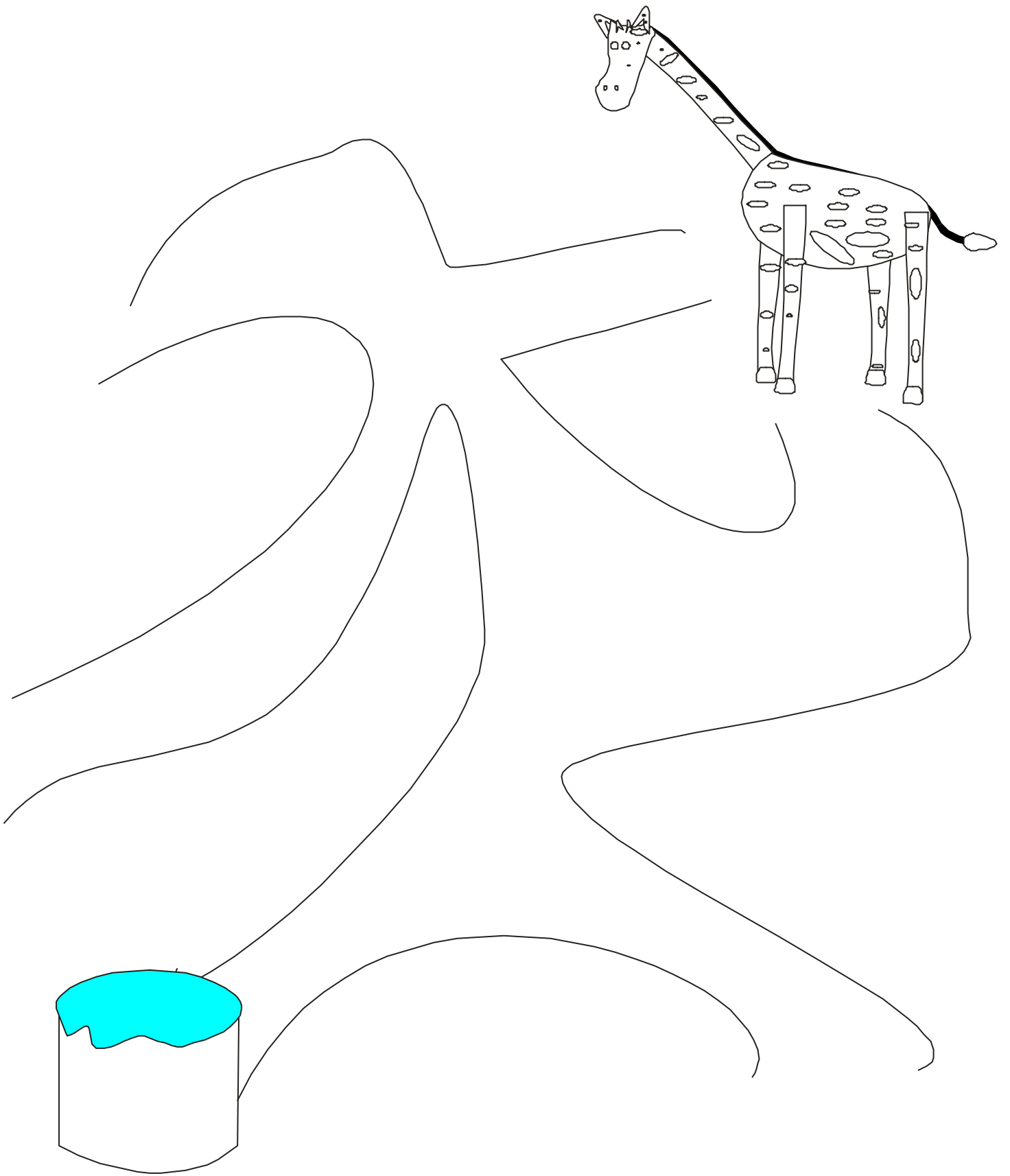

Pica dentro del camino que lleva a la jirafa a beber agua.

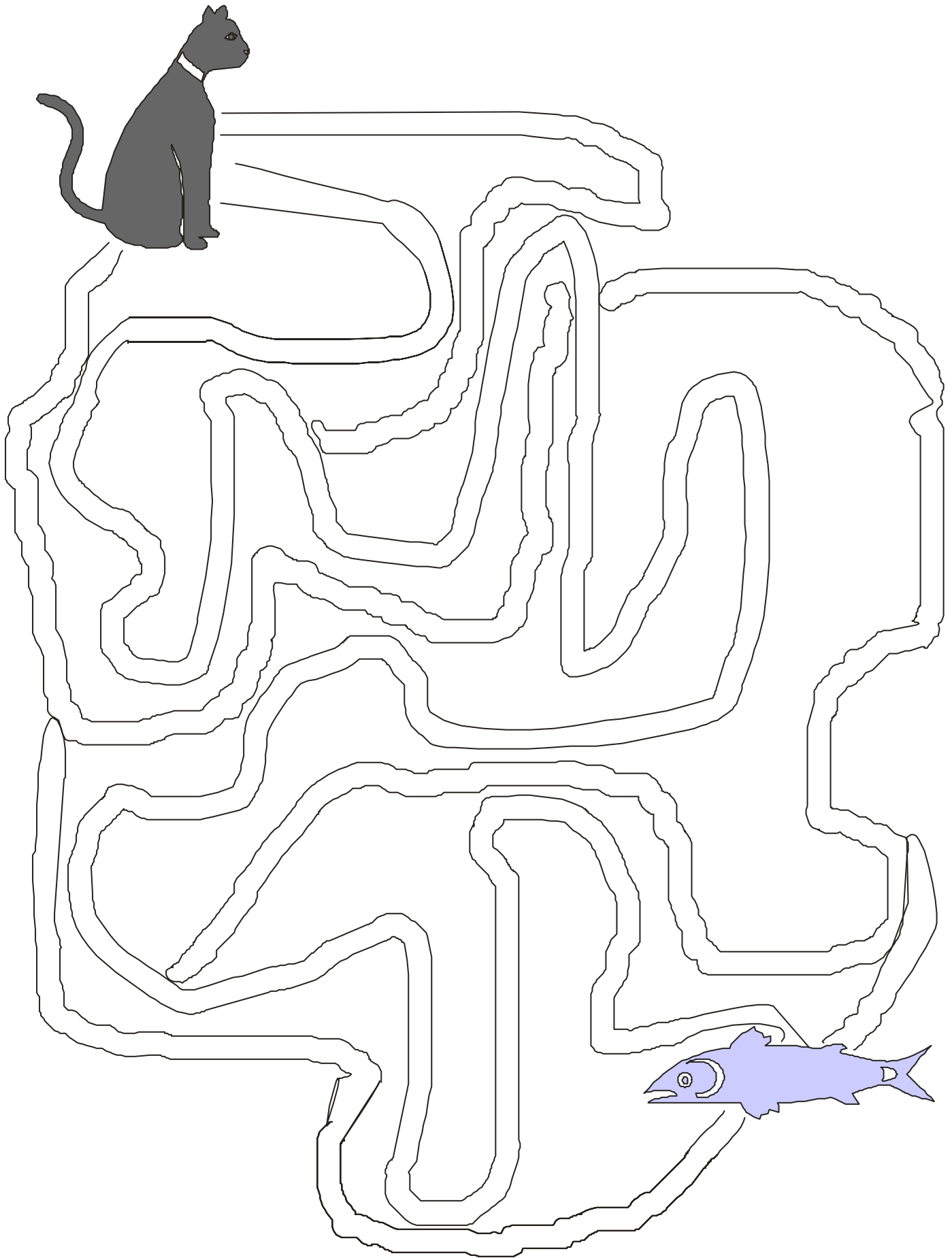

Pinta el camino que lleva al gato al pez y después pica dentro de éste.

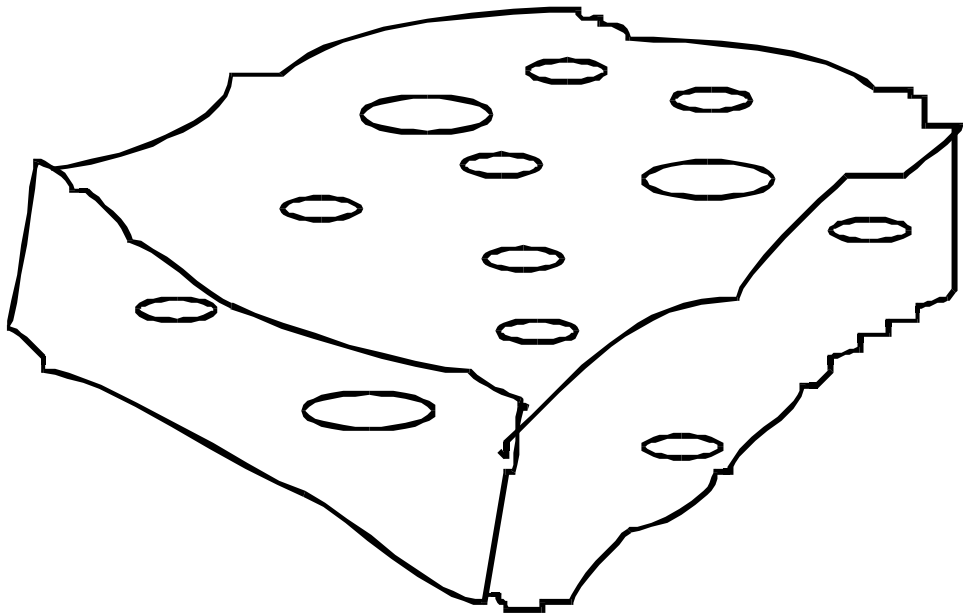
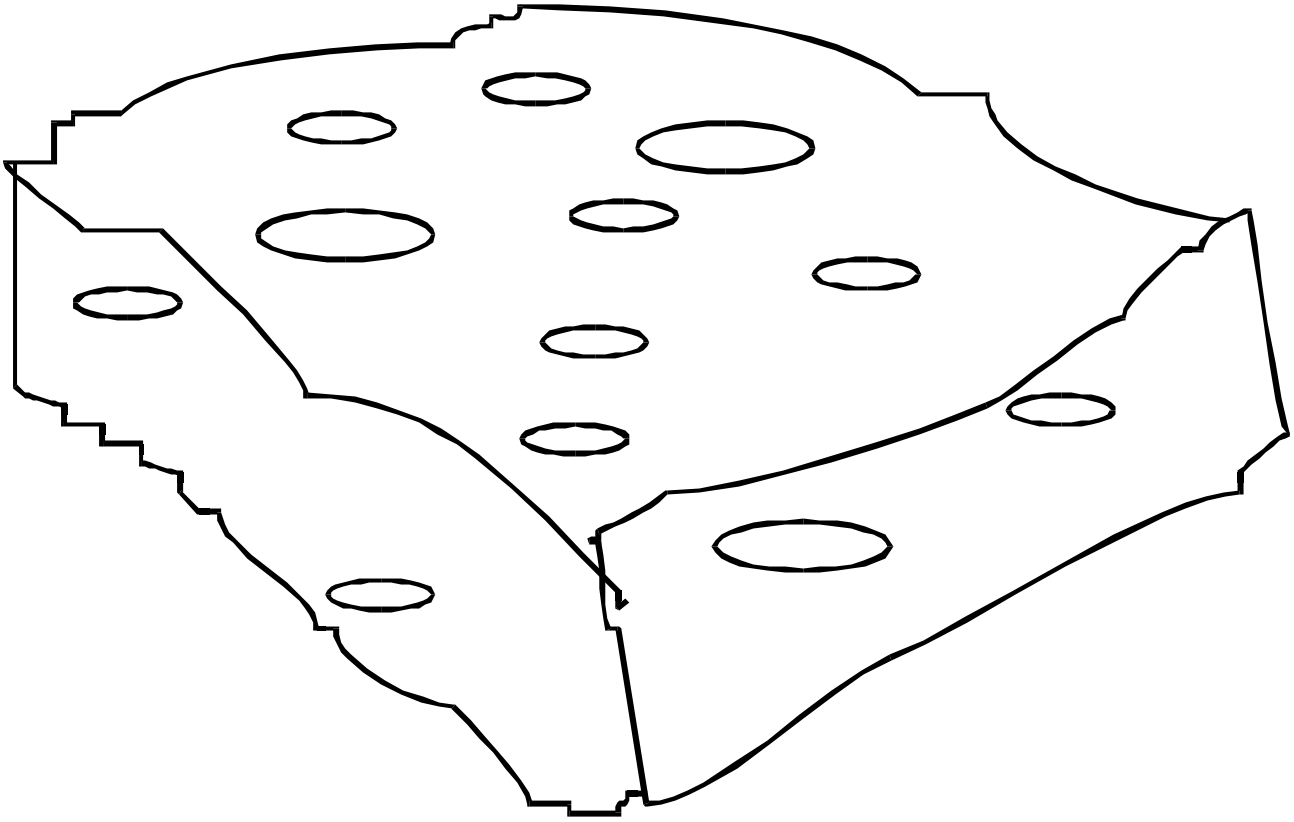

Pica dentro de la esponja grande.

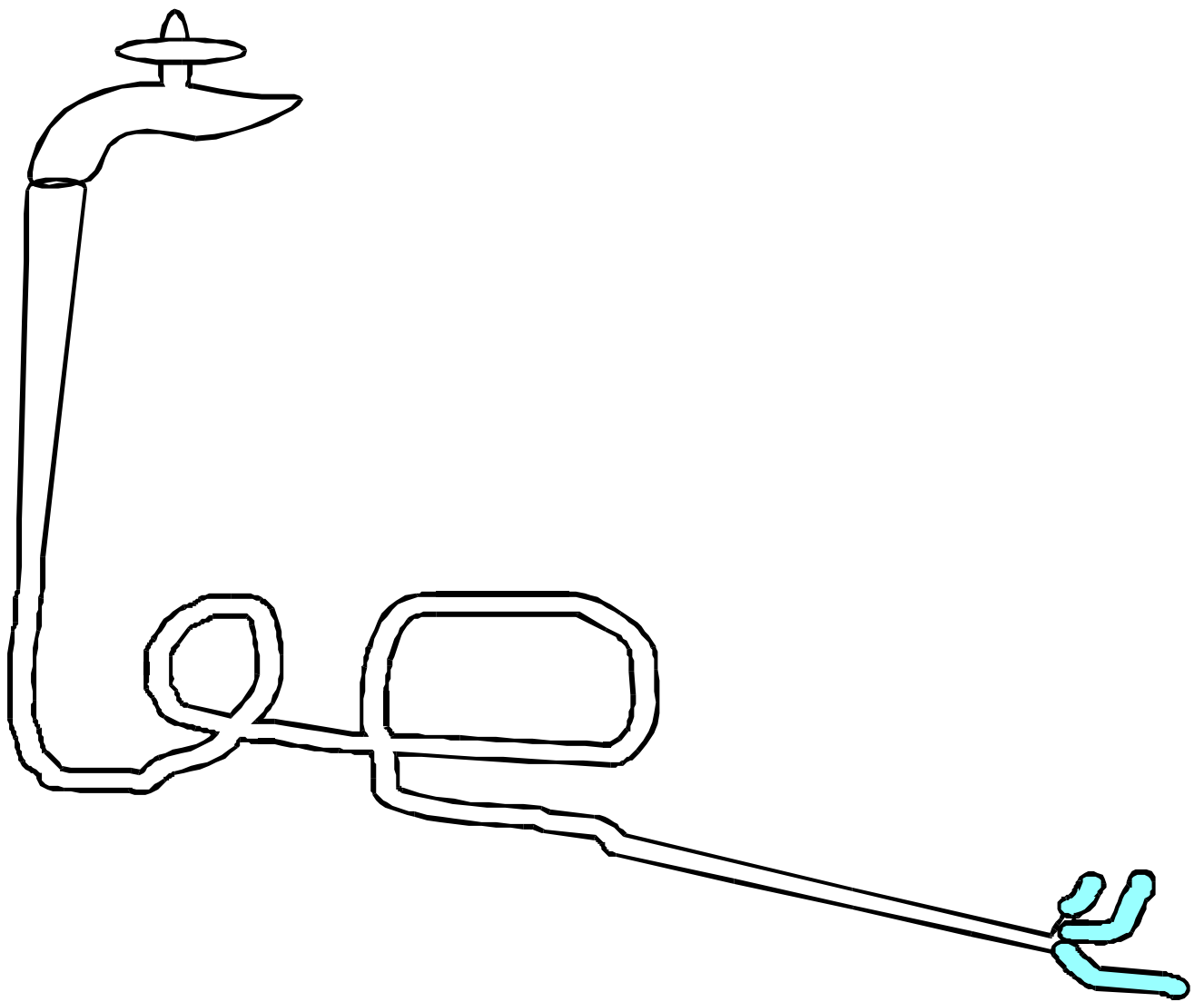
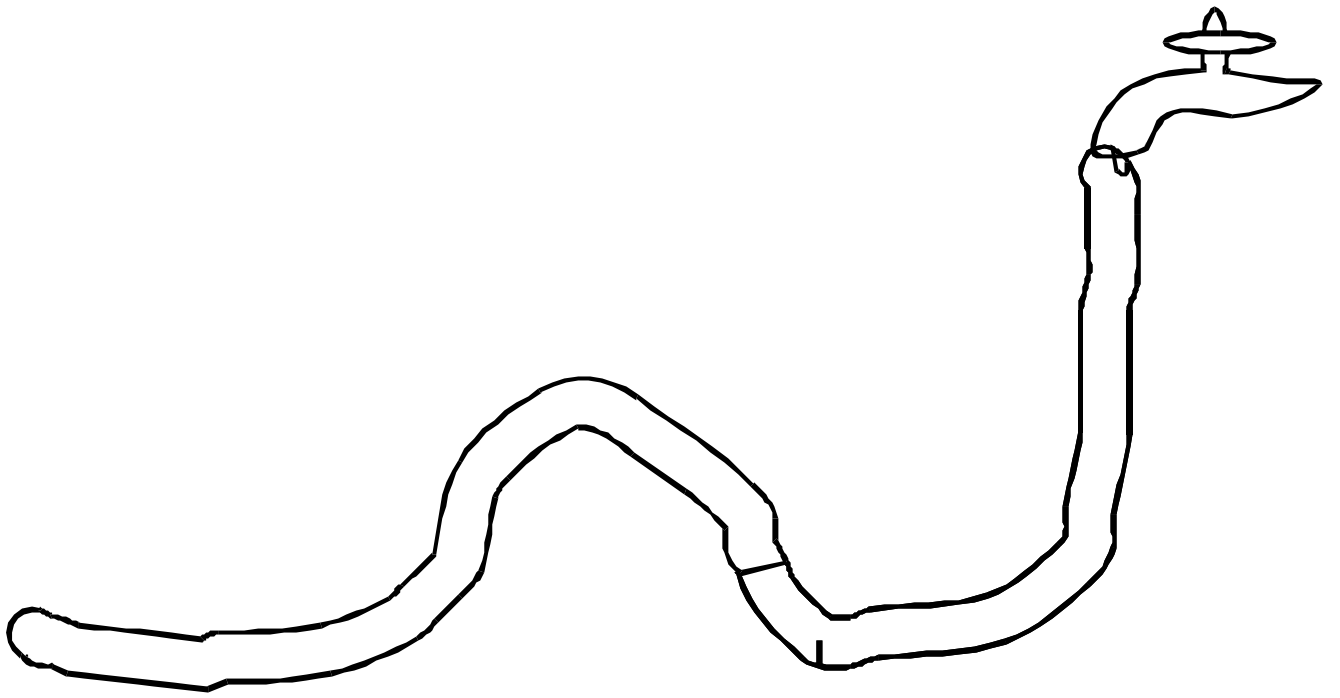

Colorea la manquera larga.

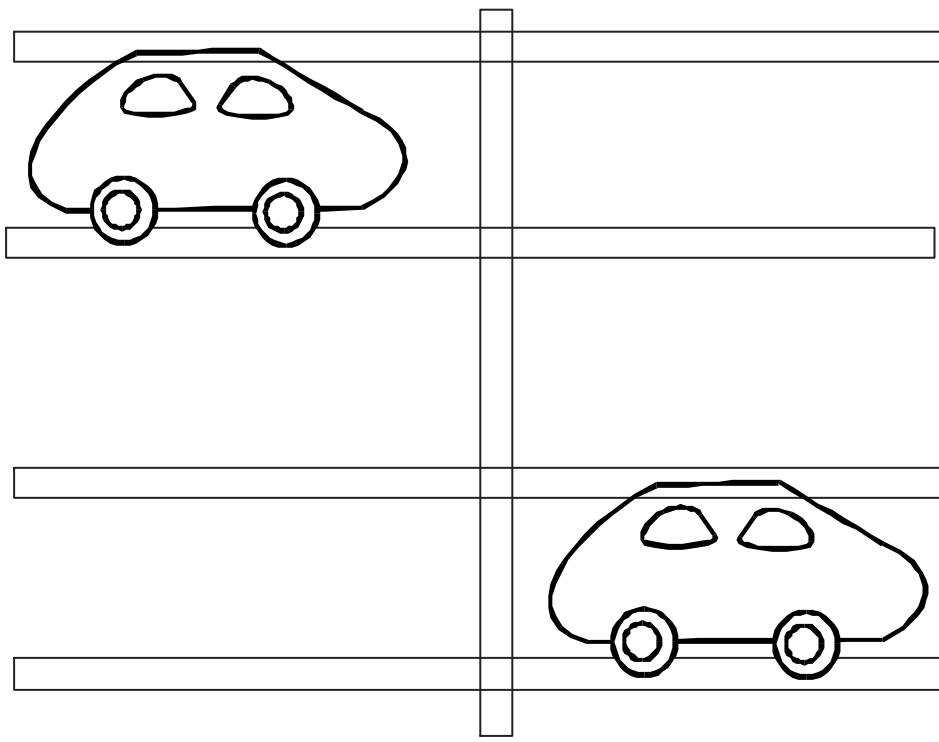
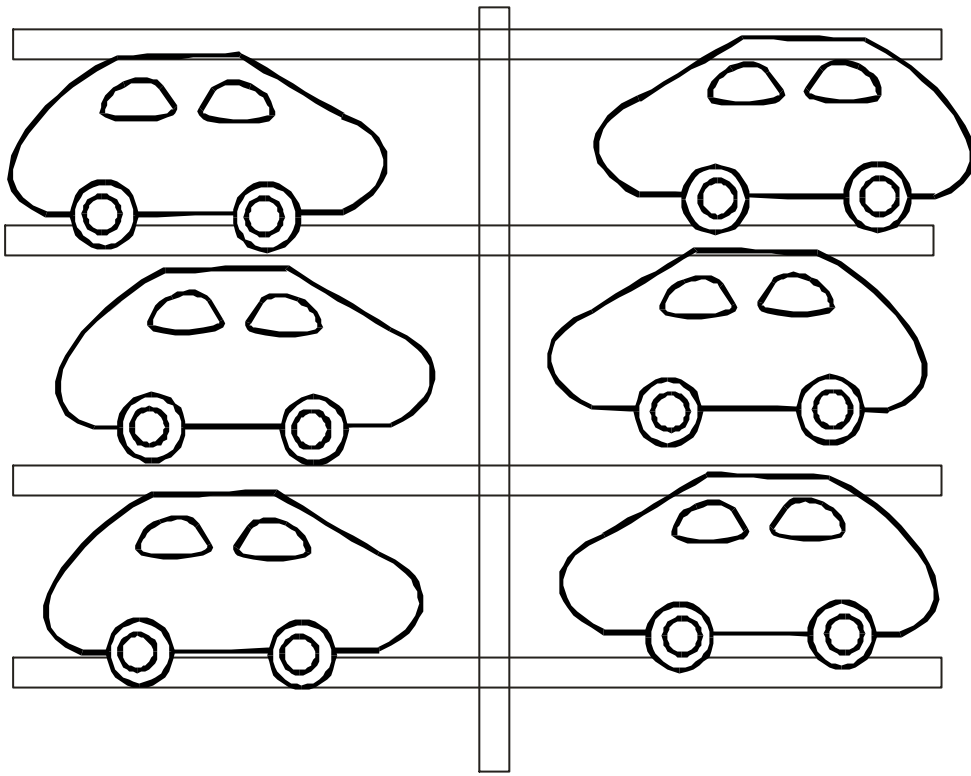

Pinta el aparcamiento que tiene pocos coches.

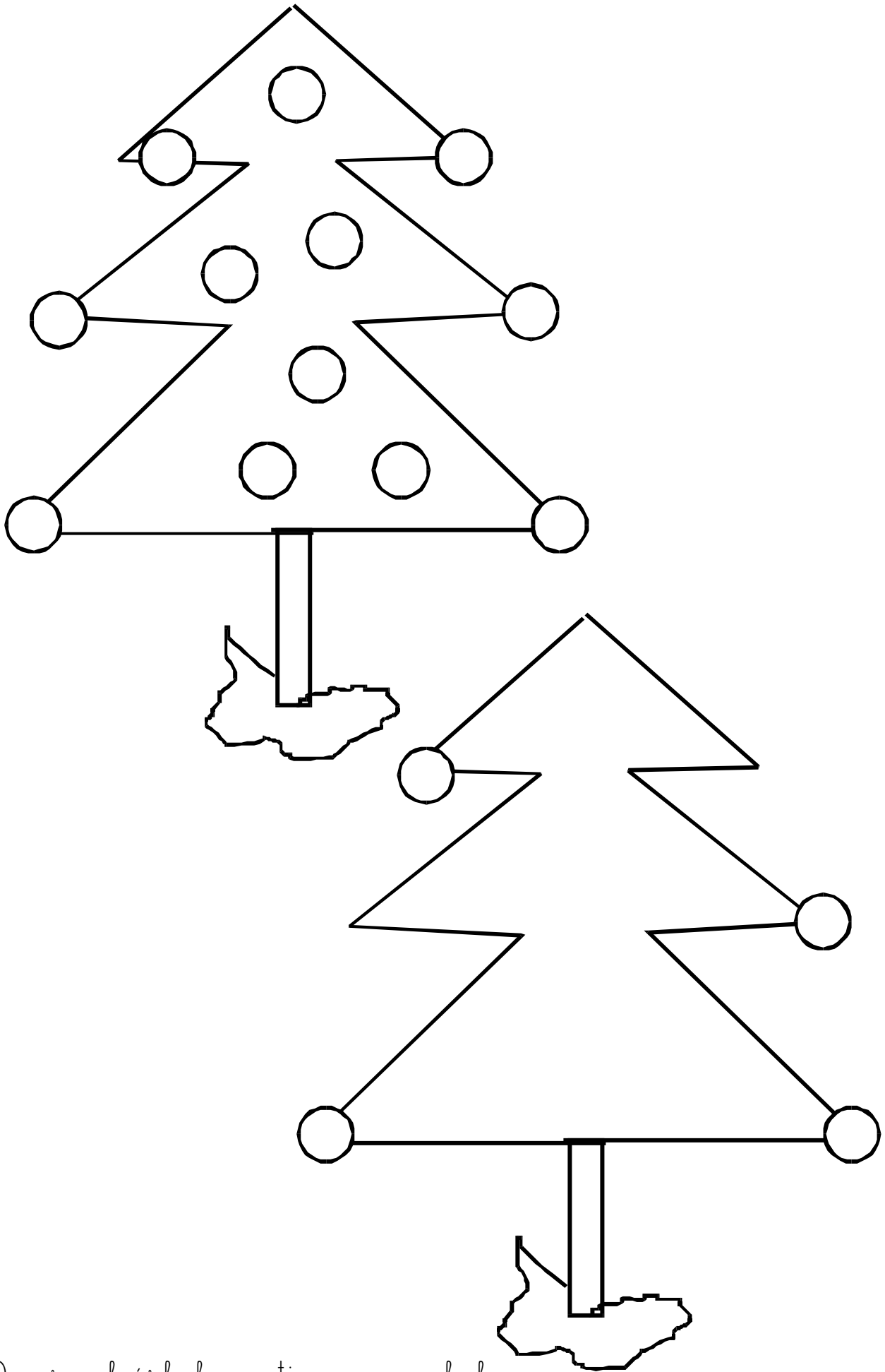

Decora el árbol que tiene pocas bolas.

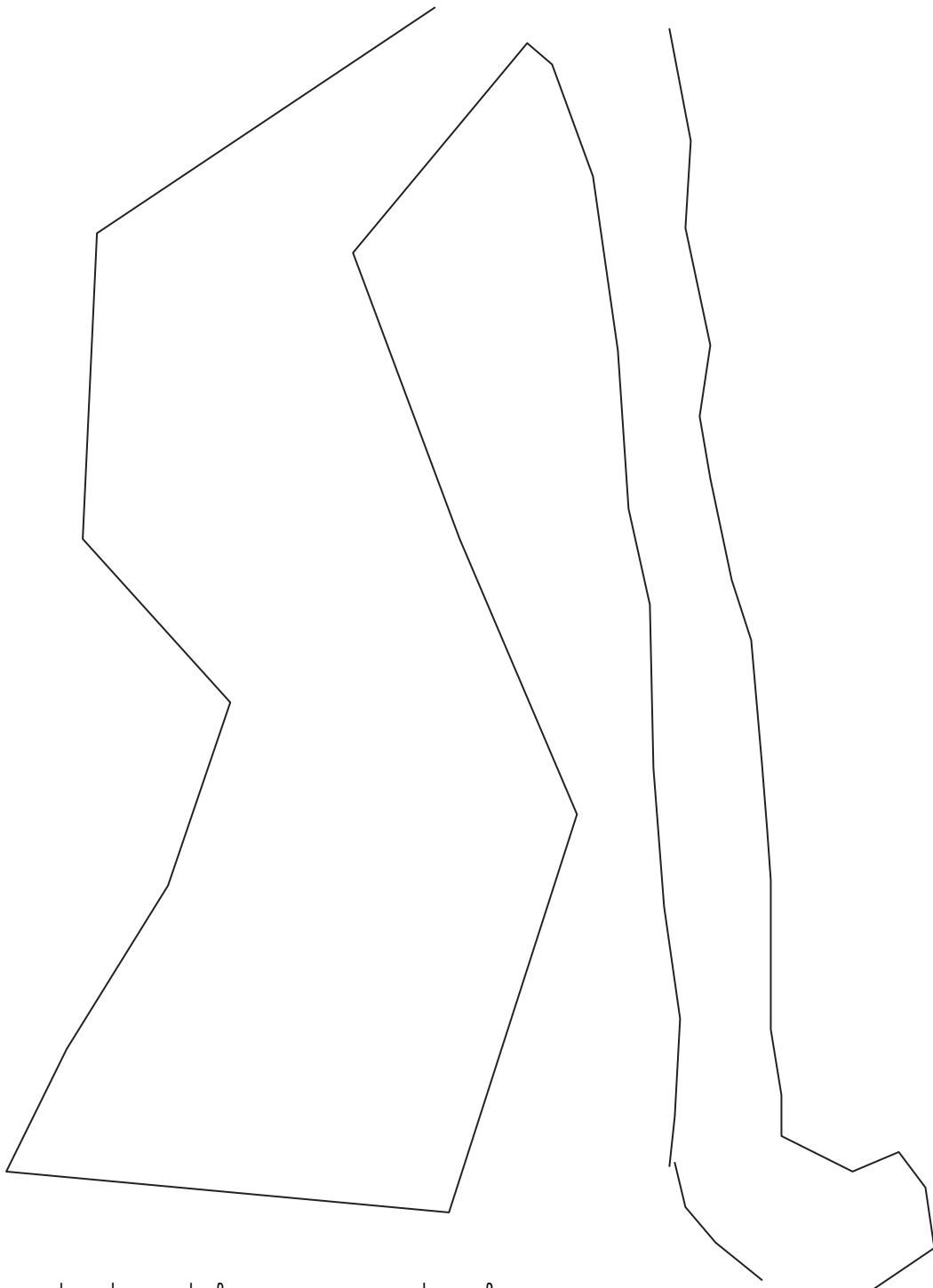
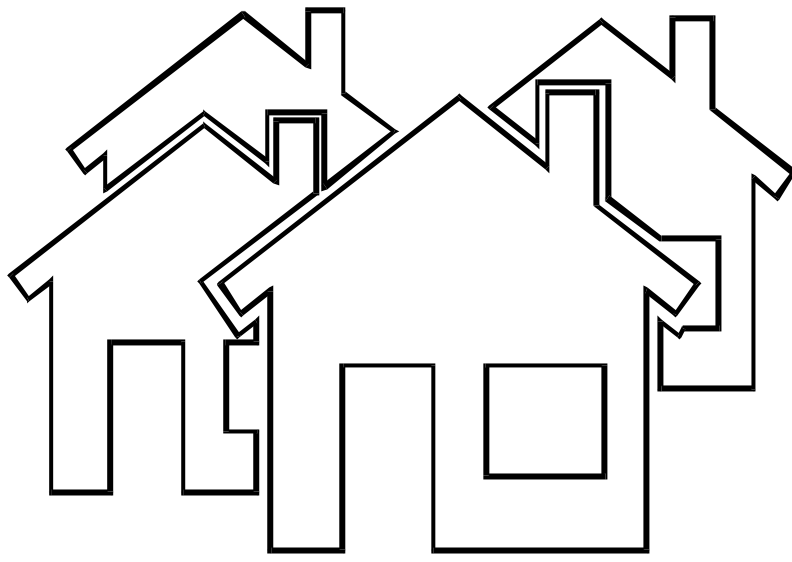

Pica dentro del camino estrecho.

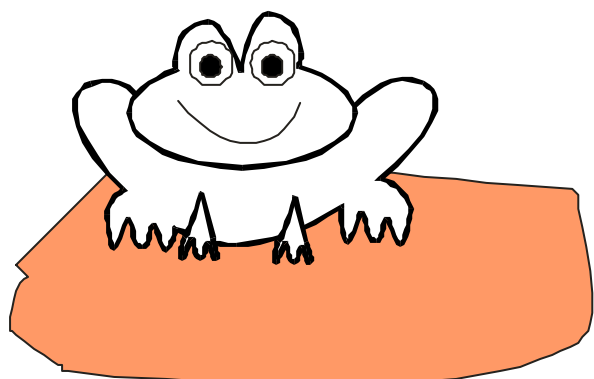
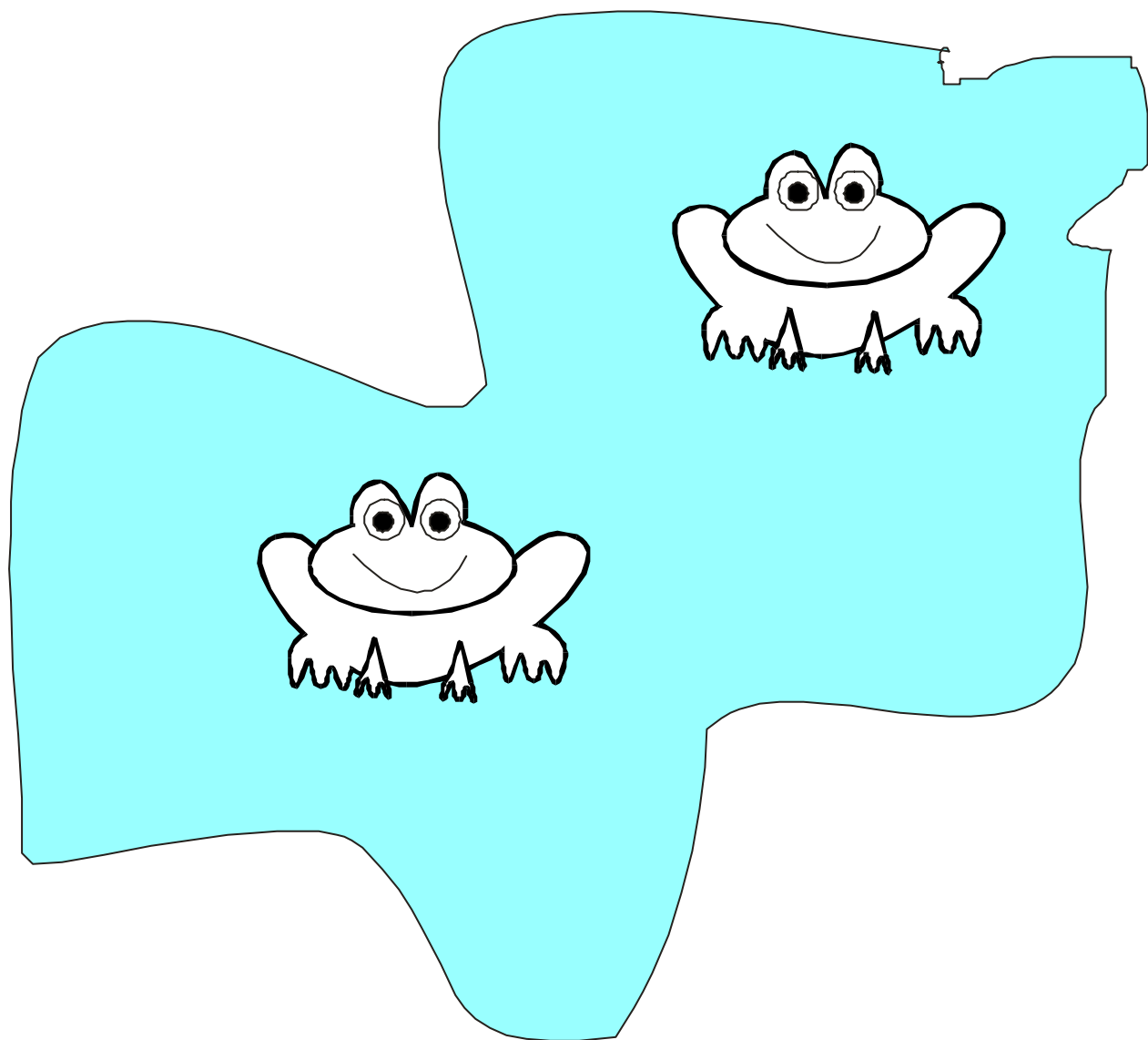
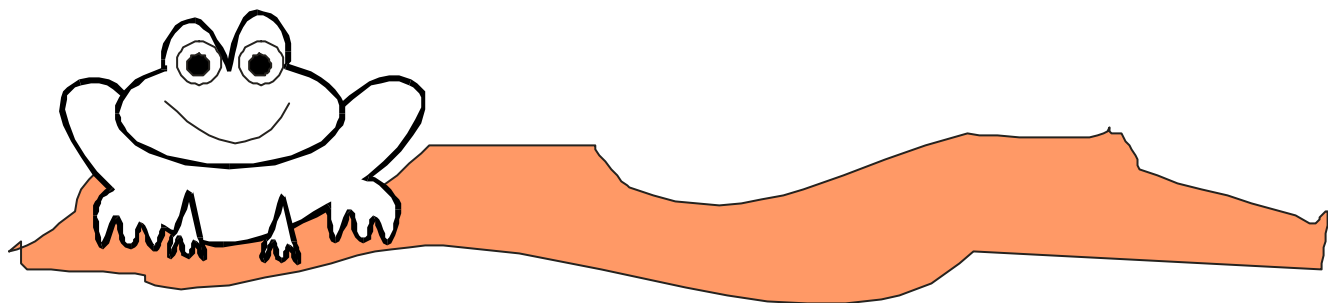

Pinta las ranas que están fuera del agua.

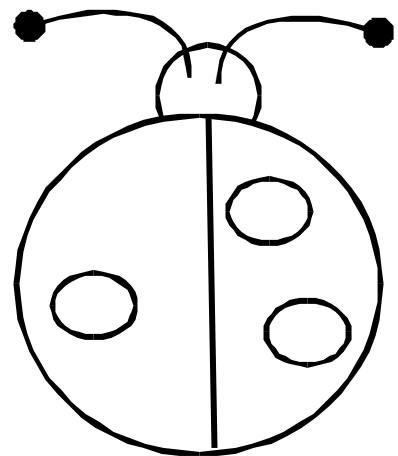
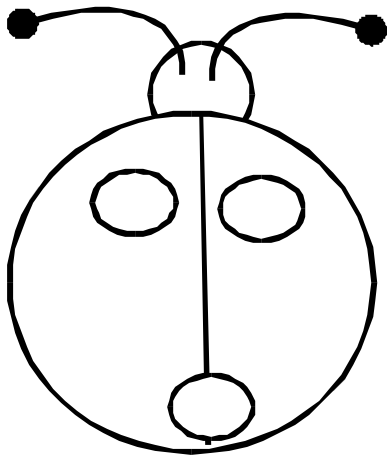
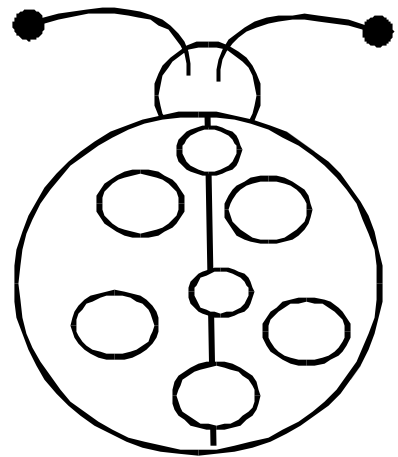
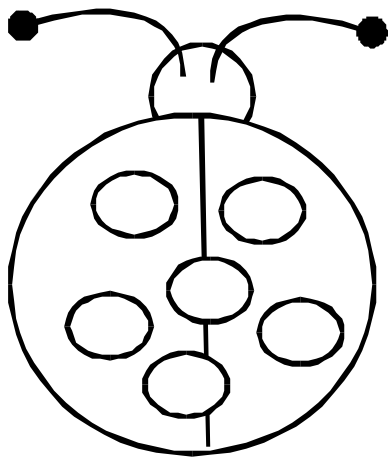
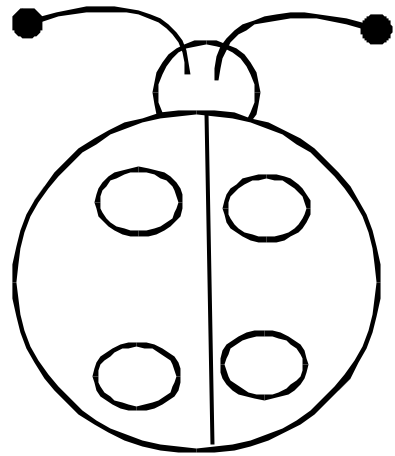
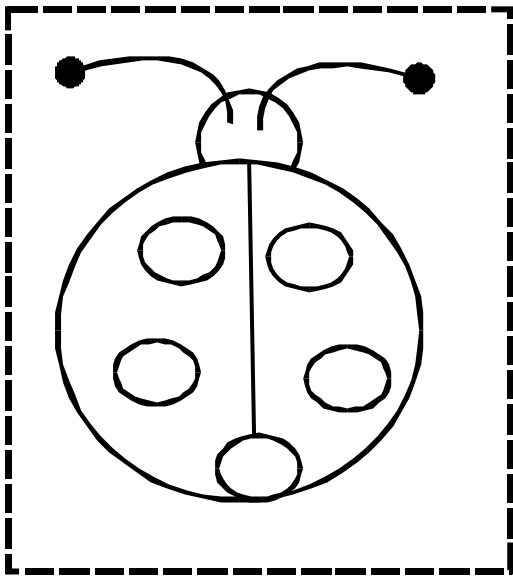

Pinta las mariquitas que tienen menos manchas que el modelo.

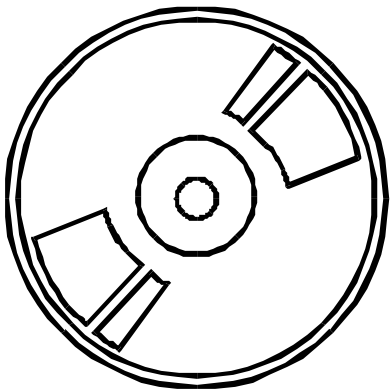
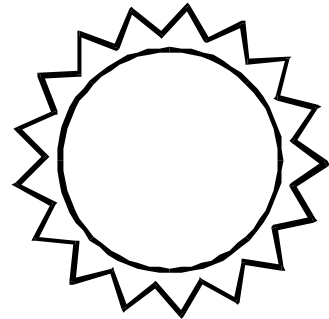
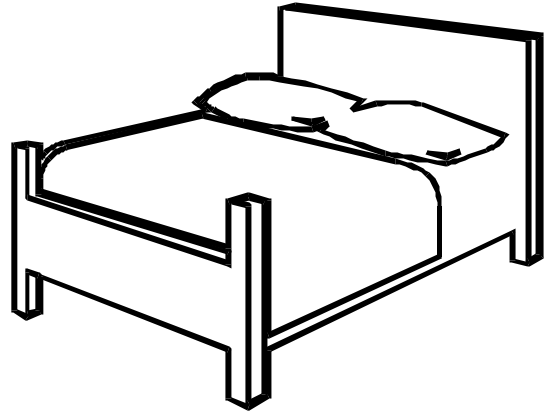
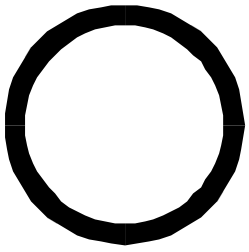

Pinta los objetos que tienen forma redonda.

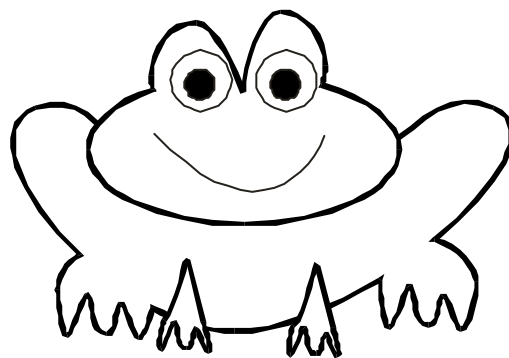
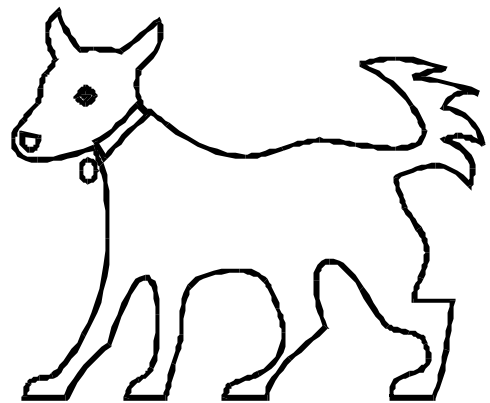
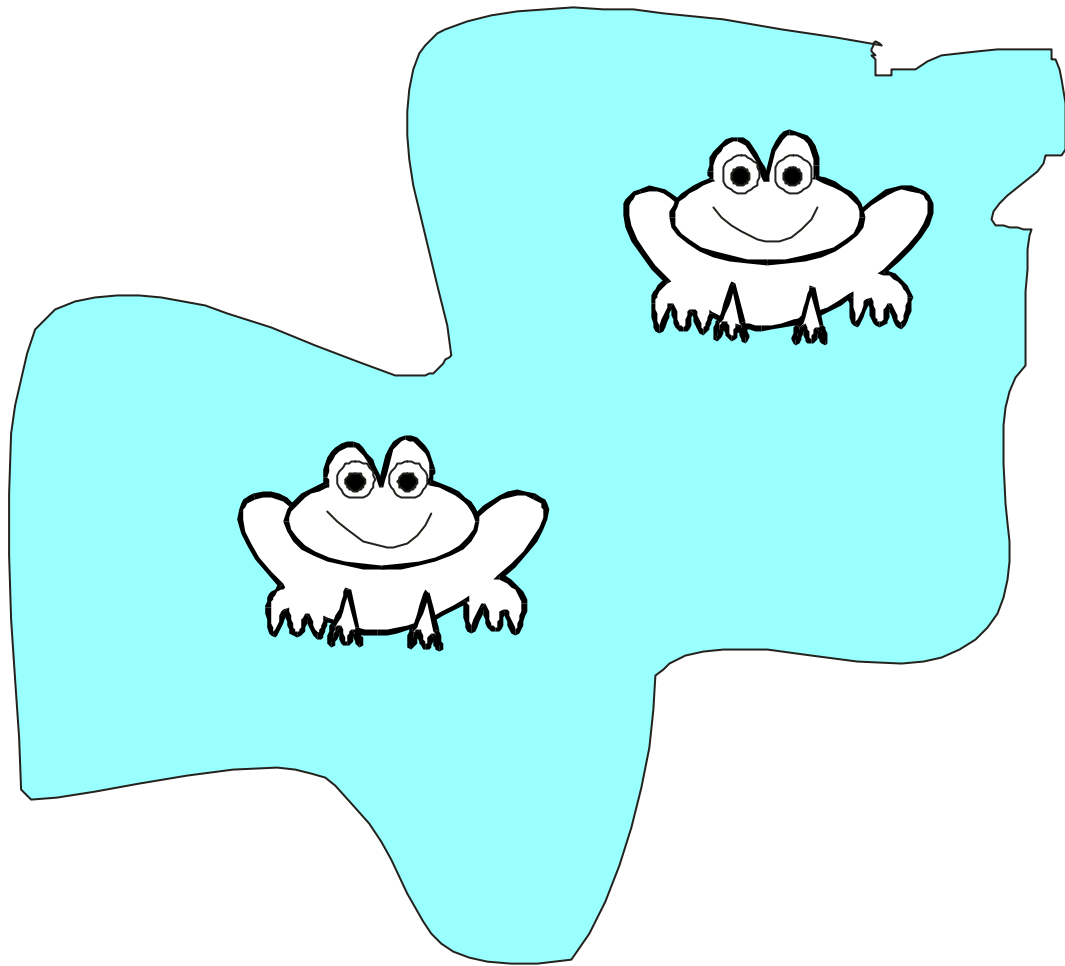

Pinta el animal que es igual a los que están en el estanque.

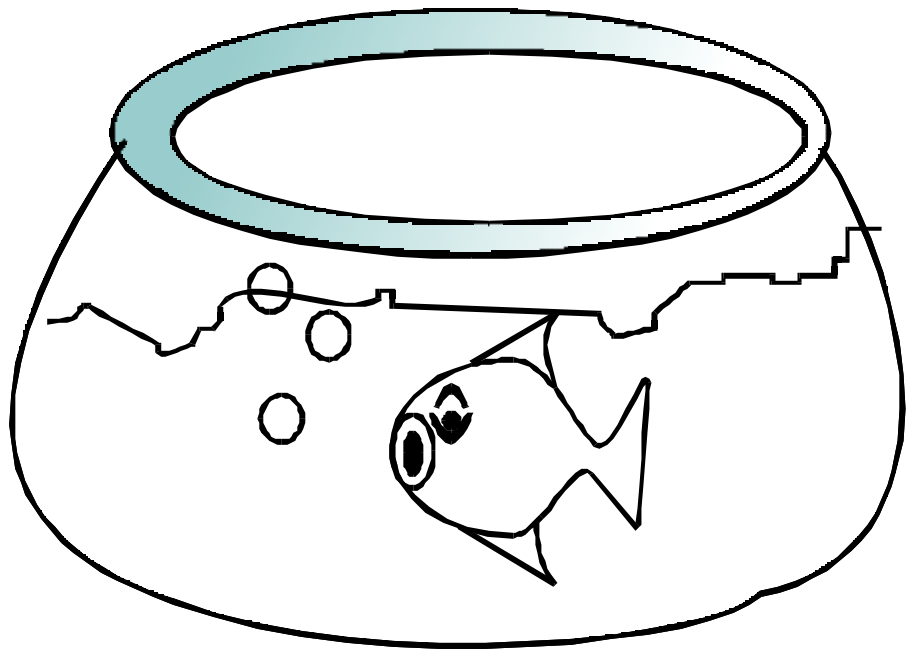
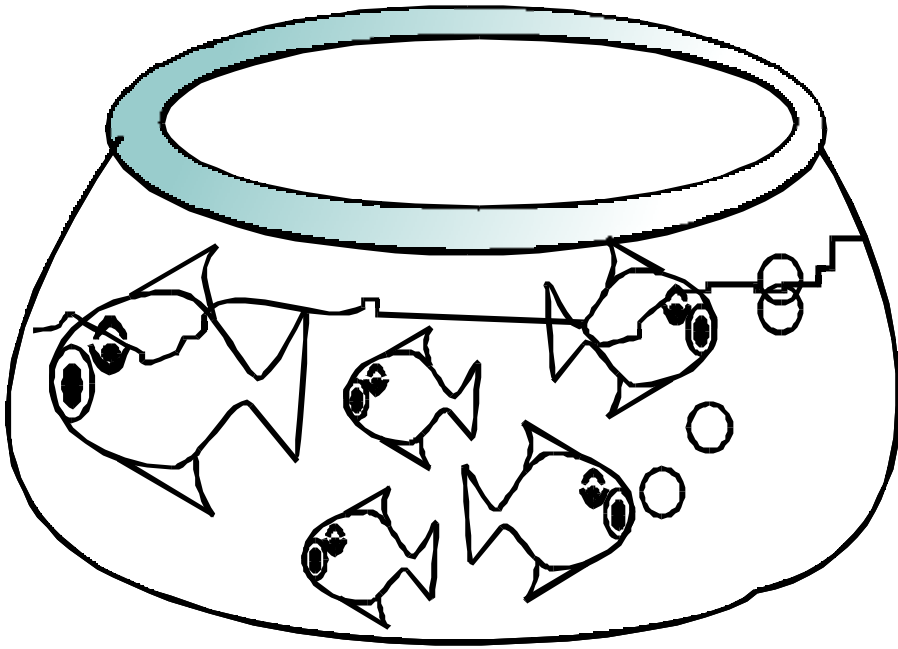

Pinta el agua de la pecera que tiene un pez.

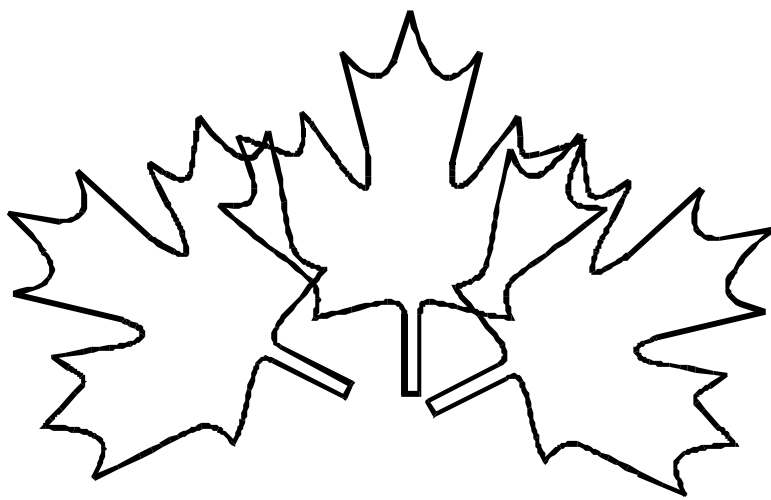
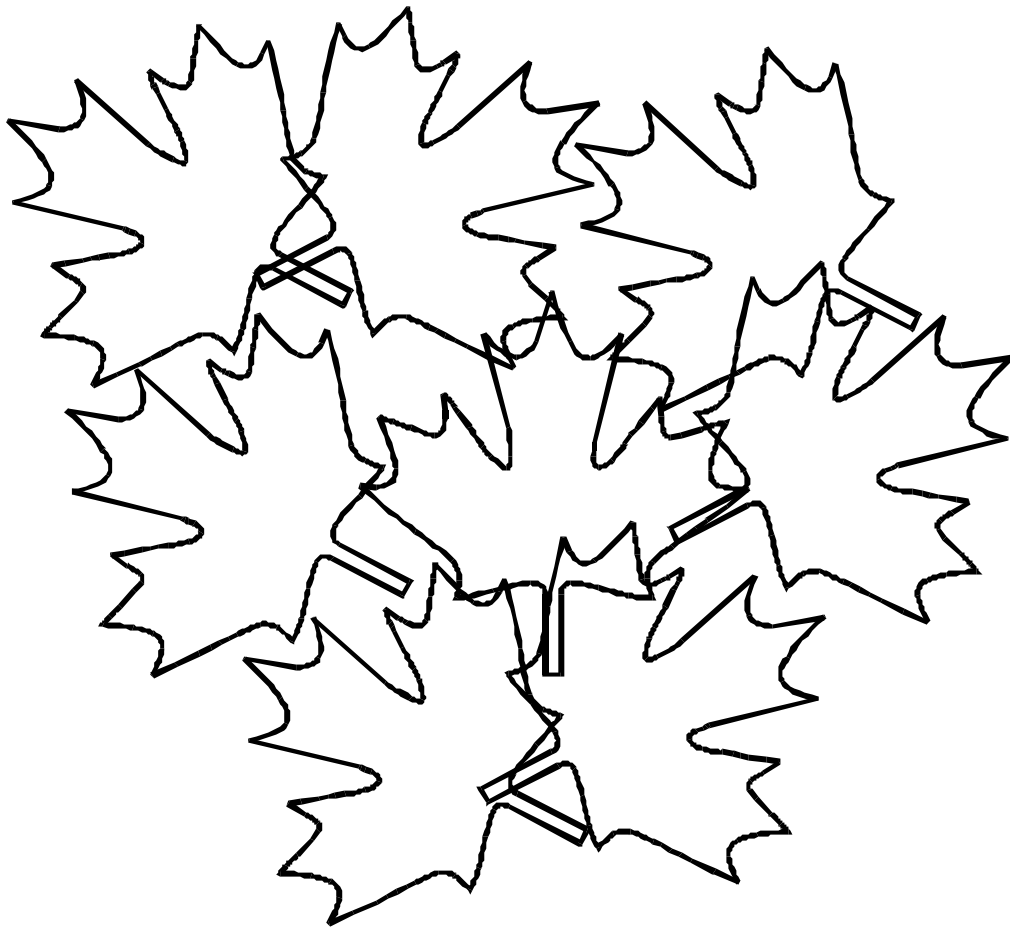

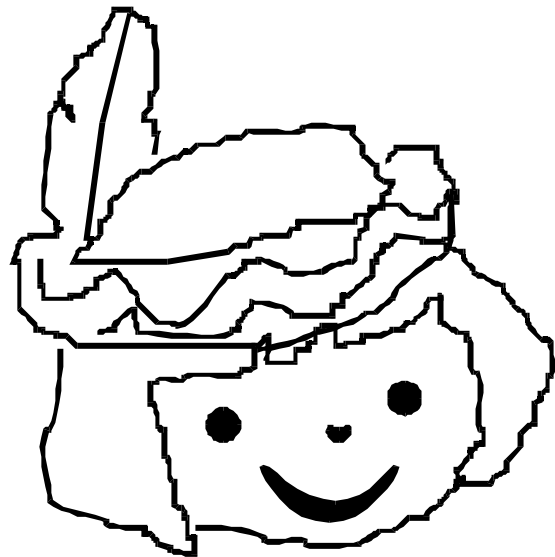
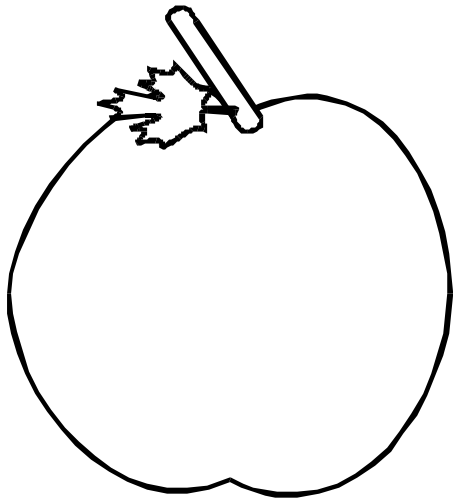
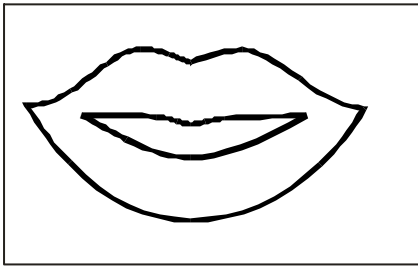

Rodea el montón que tiene muchas hojas.
Pinta donde hay pocas hojas.



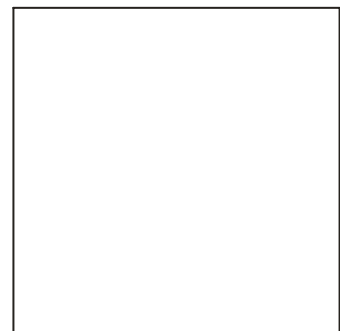
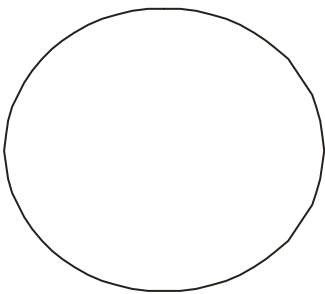
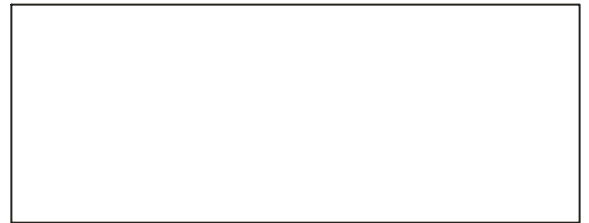
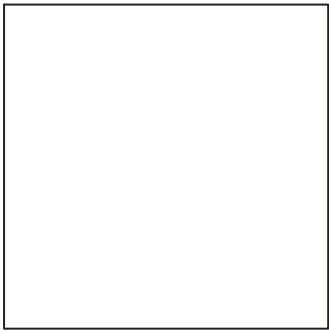
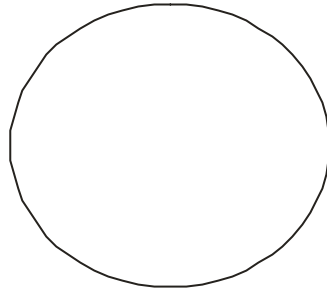
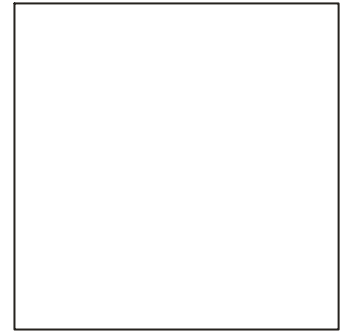
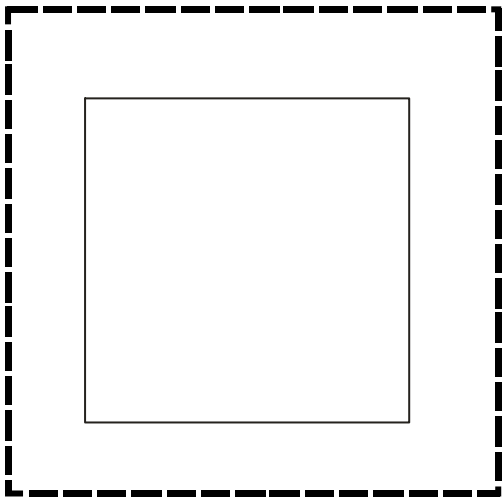

Pinta las cosas comestibles.

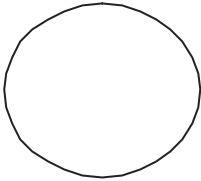
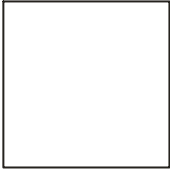

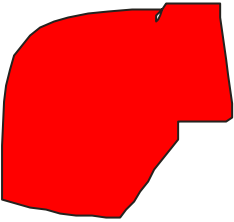
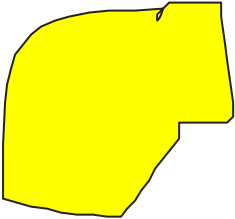
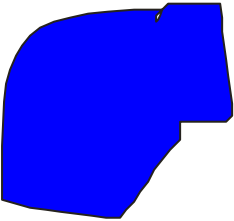
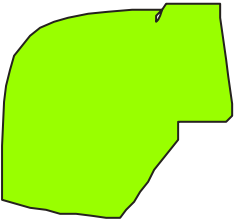
Colorea los cuadrados.

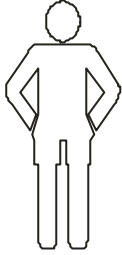
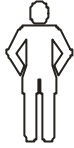
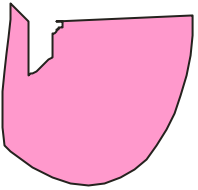
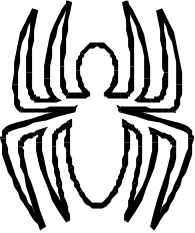

Completa la tabla.

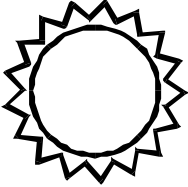
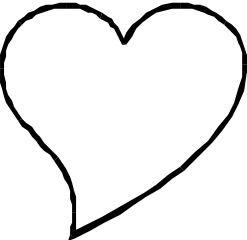

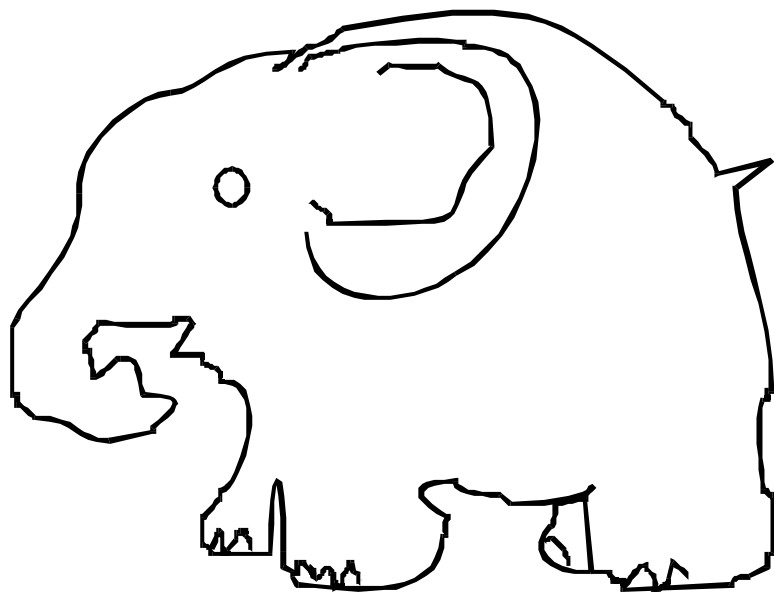
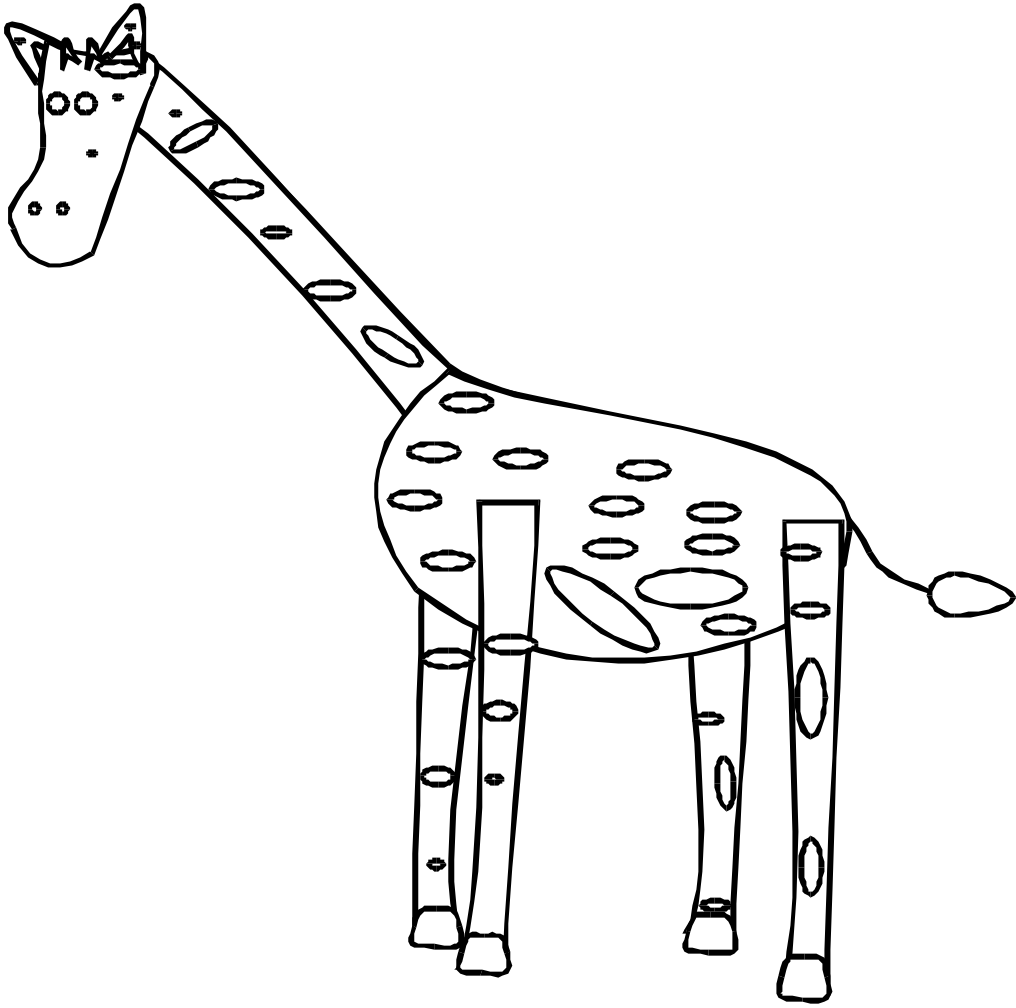

Pintar el animal que tiene el cuello largo.

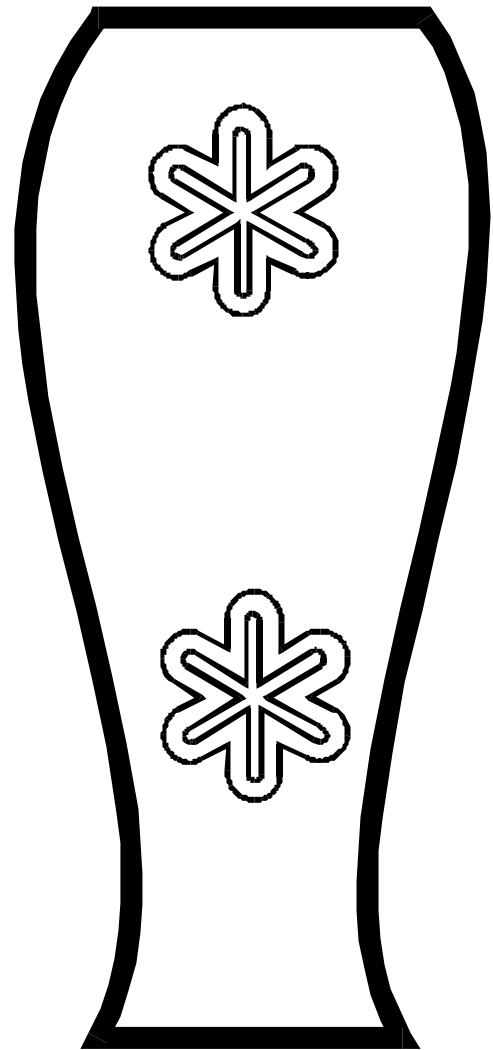
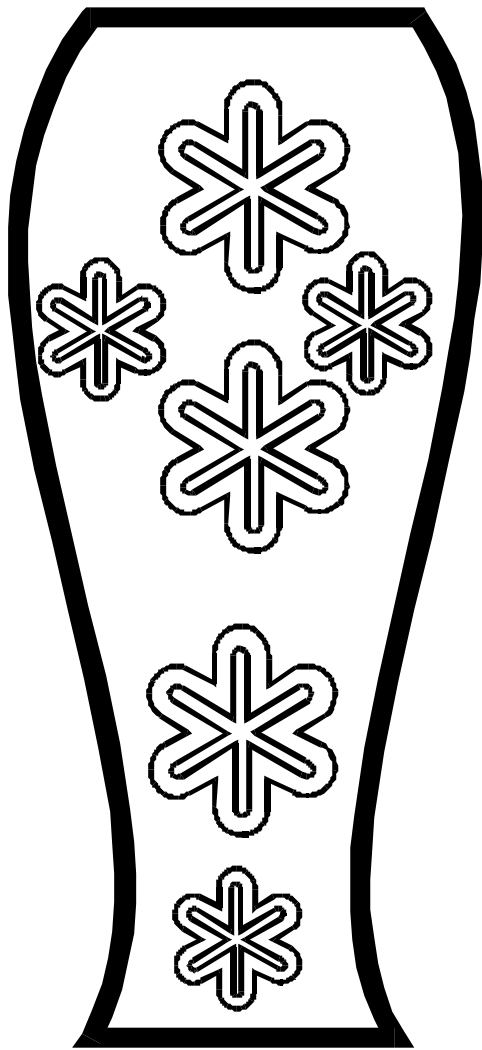

Picar y sacar el jarrón con pocas flores. Pegar detrás papel celofán.

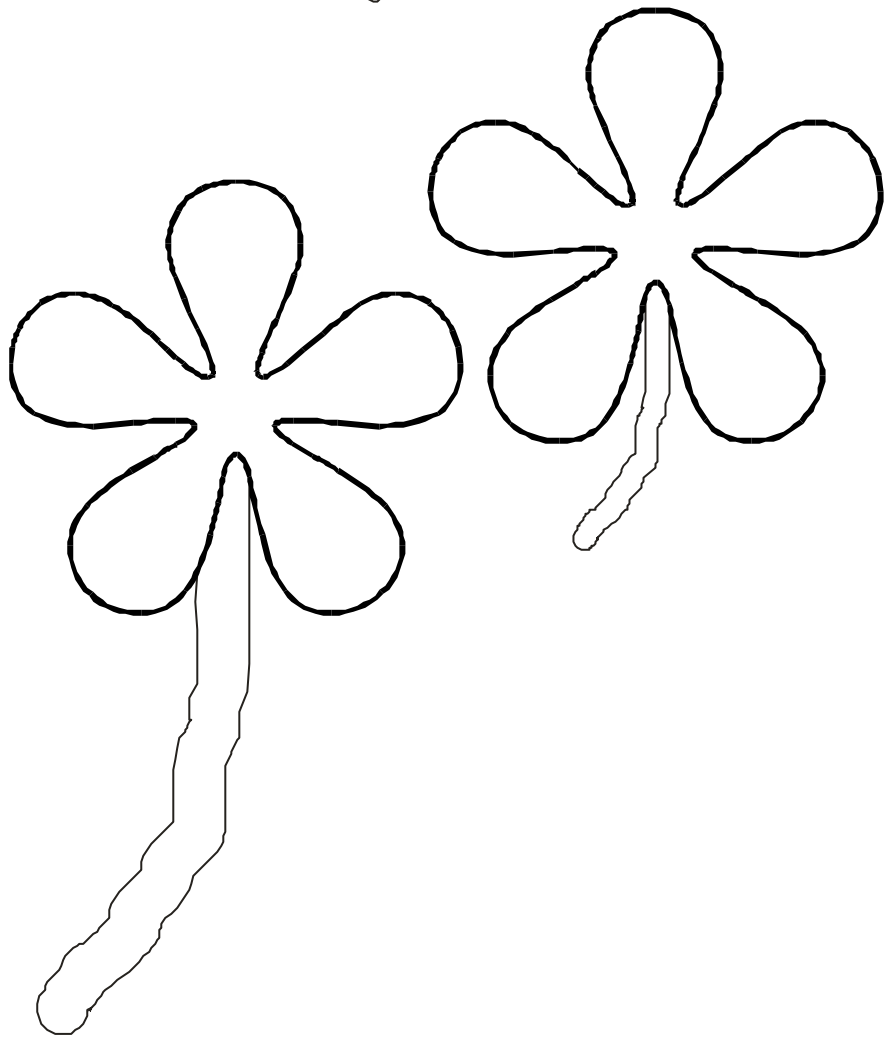
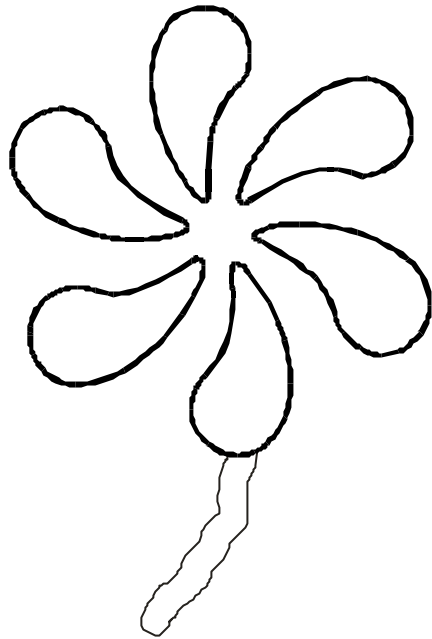
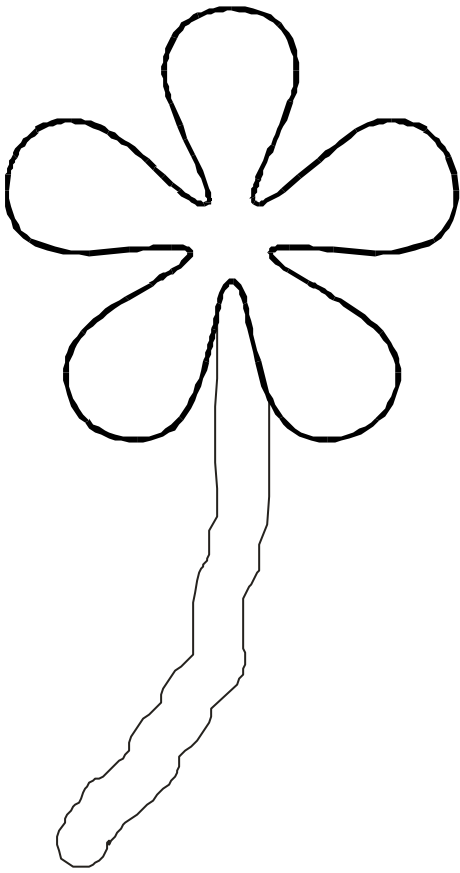

Colorear las flores con rabo largo.

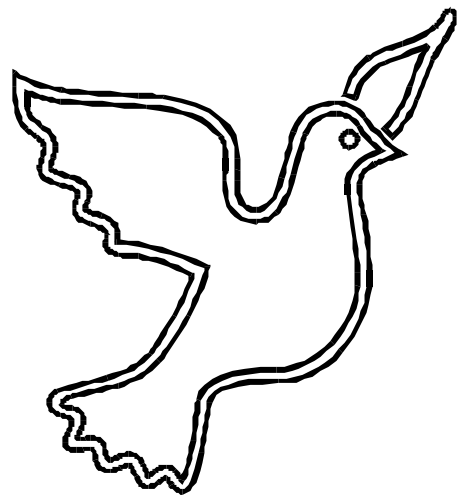
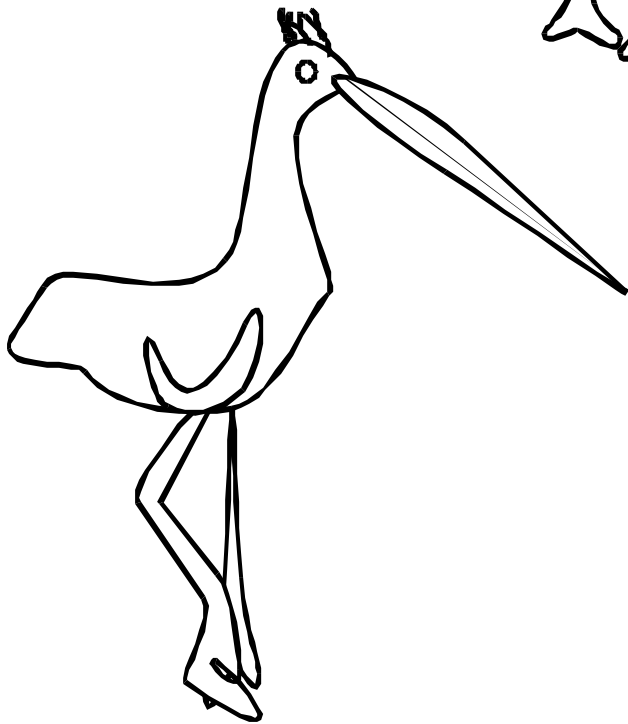
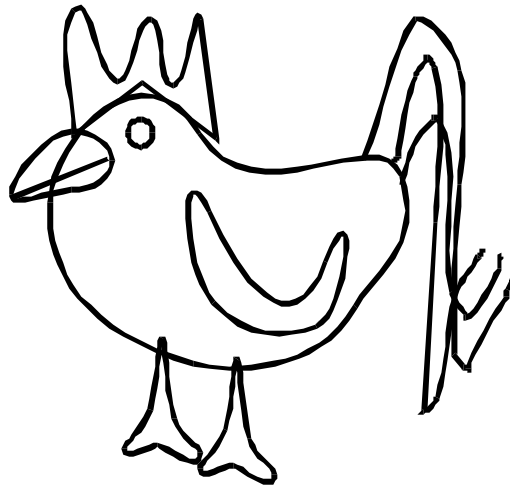
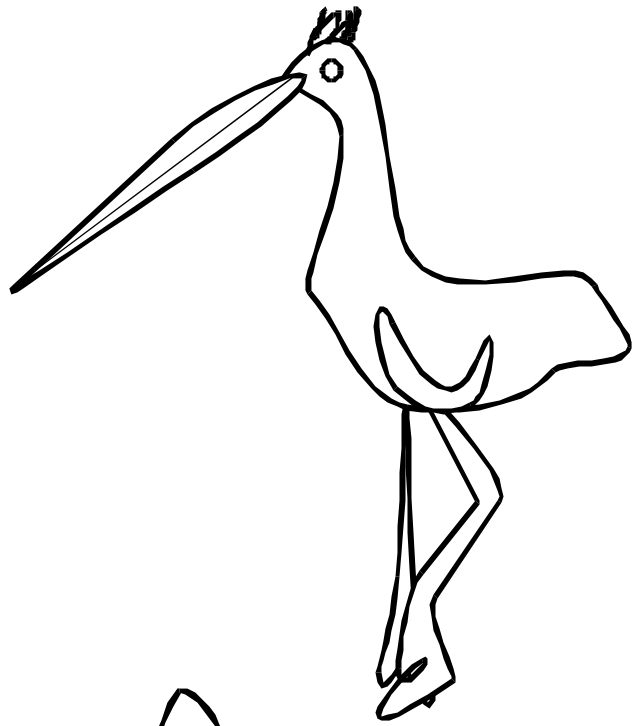

Pinta los animales que tienen el pico corto.

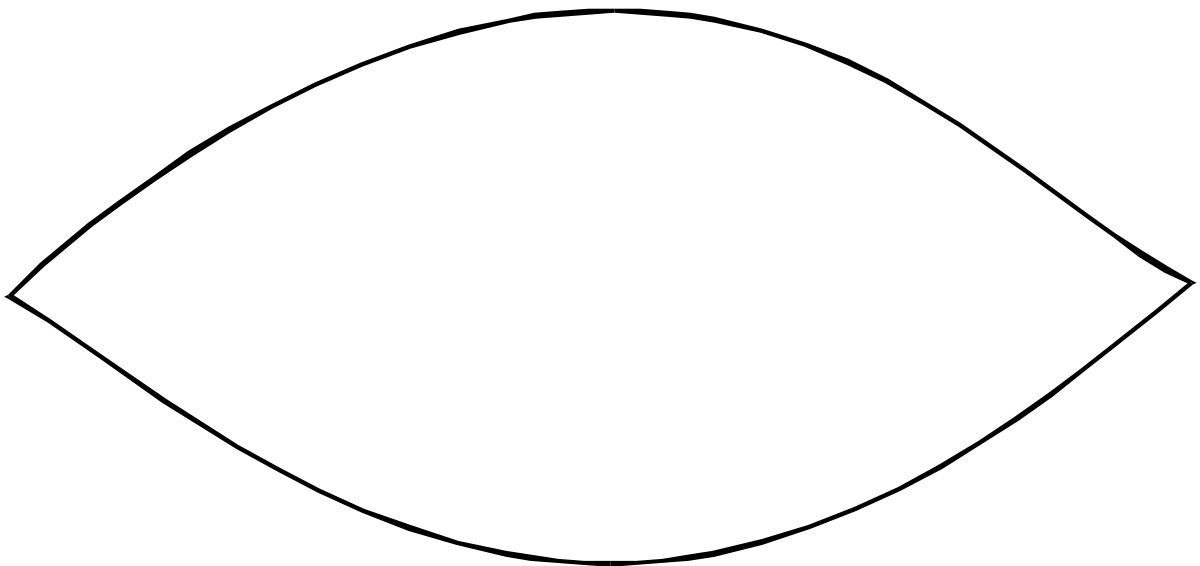
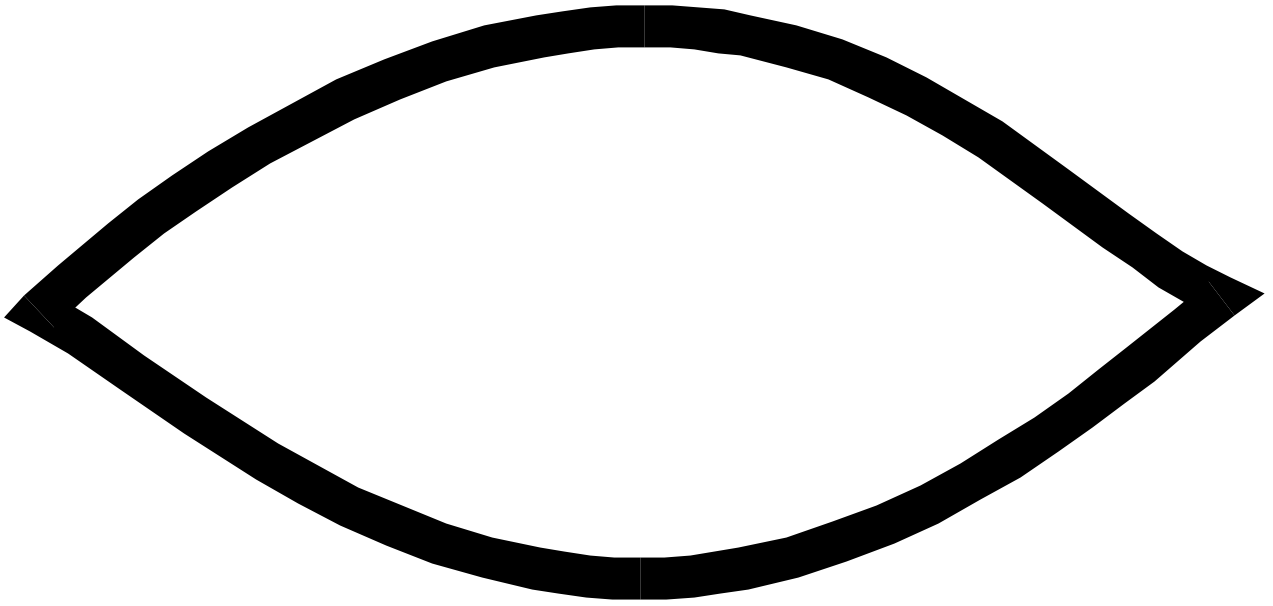

Pinta el limón con el borde fino.

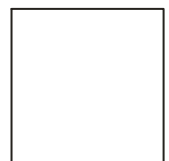
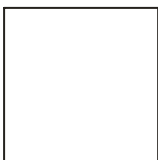
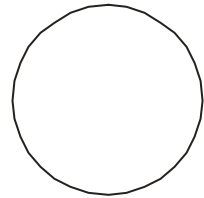
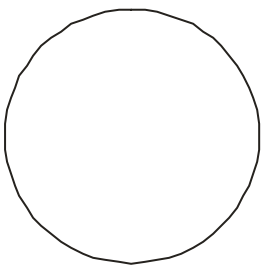
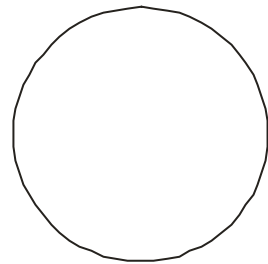
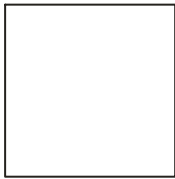
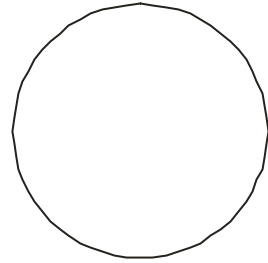
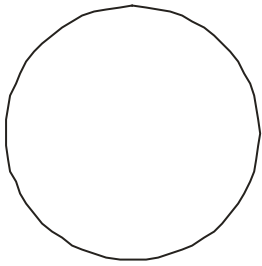
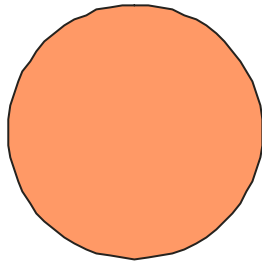
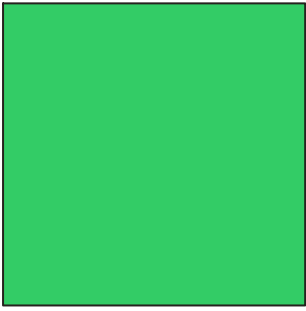

Colorea según el código.

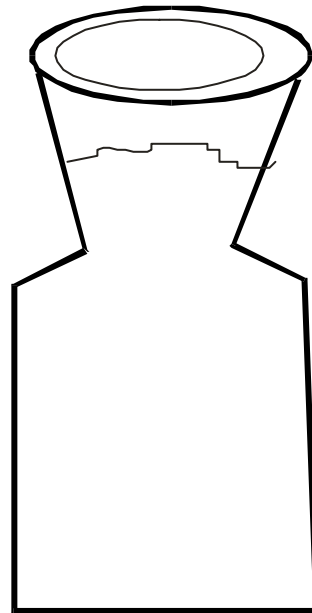
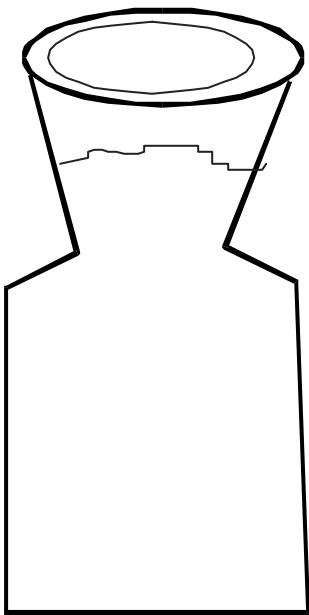
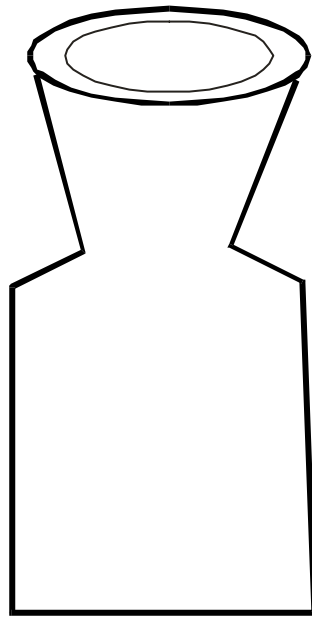
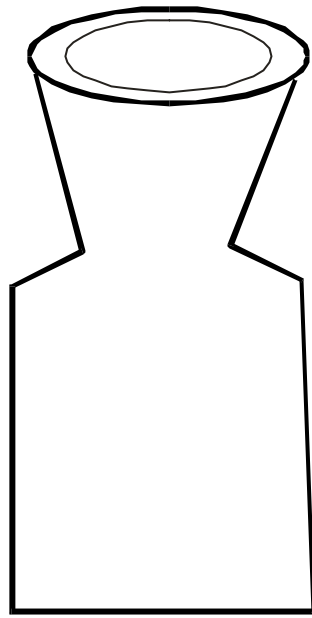
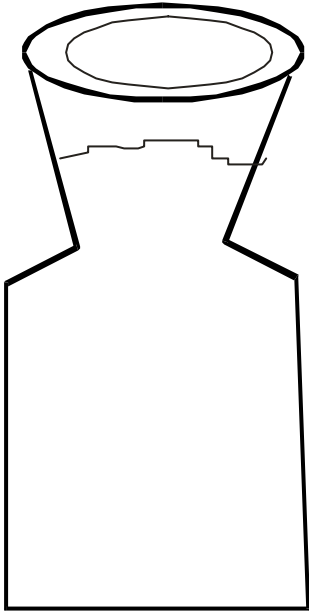

Pinta las botellas llenas.

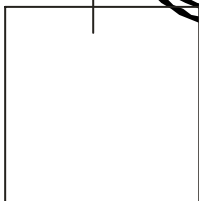
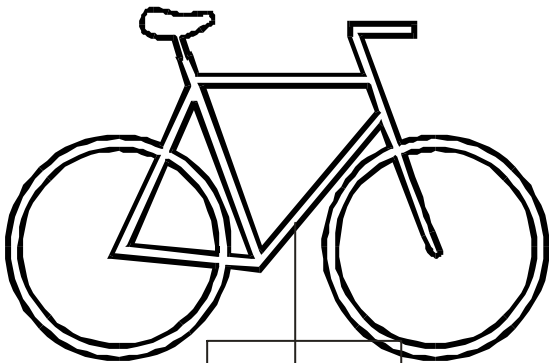
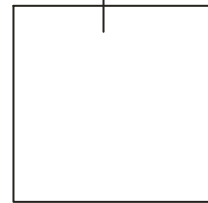
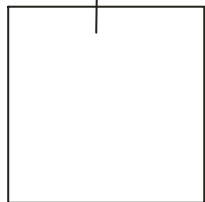
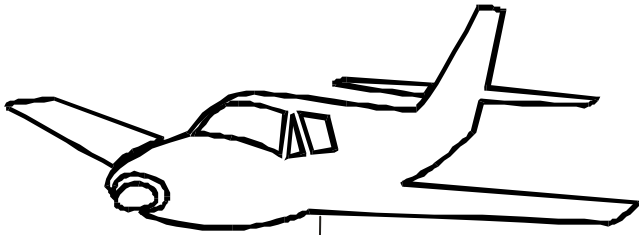
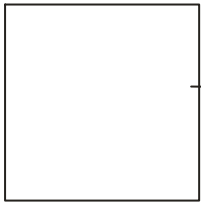
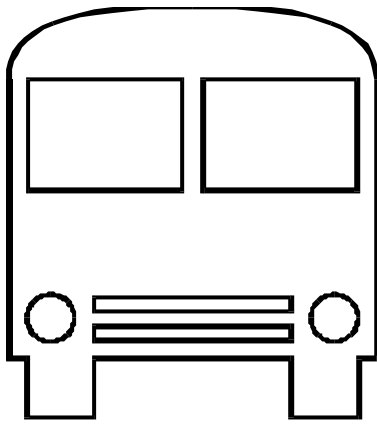

Numera los vehiculos del más rápido al más lento.

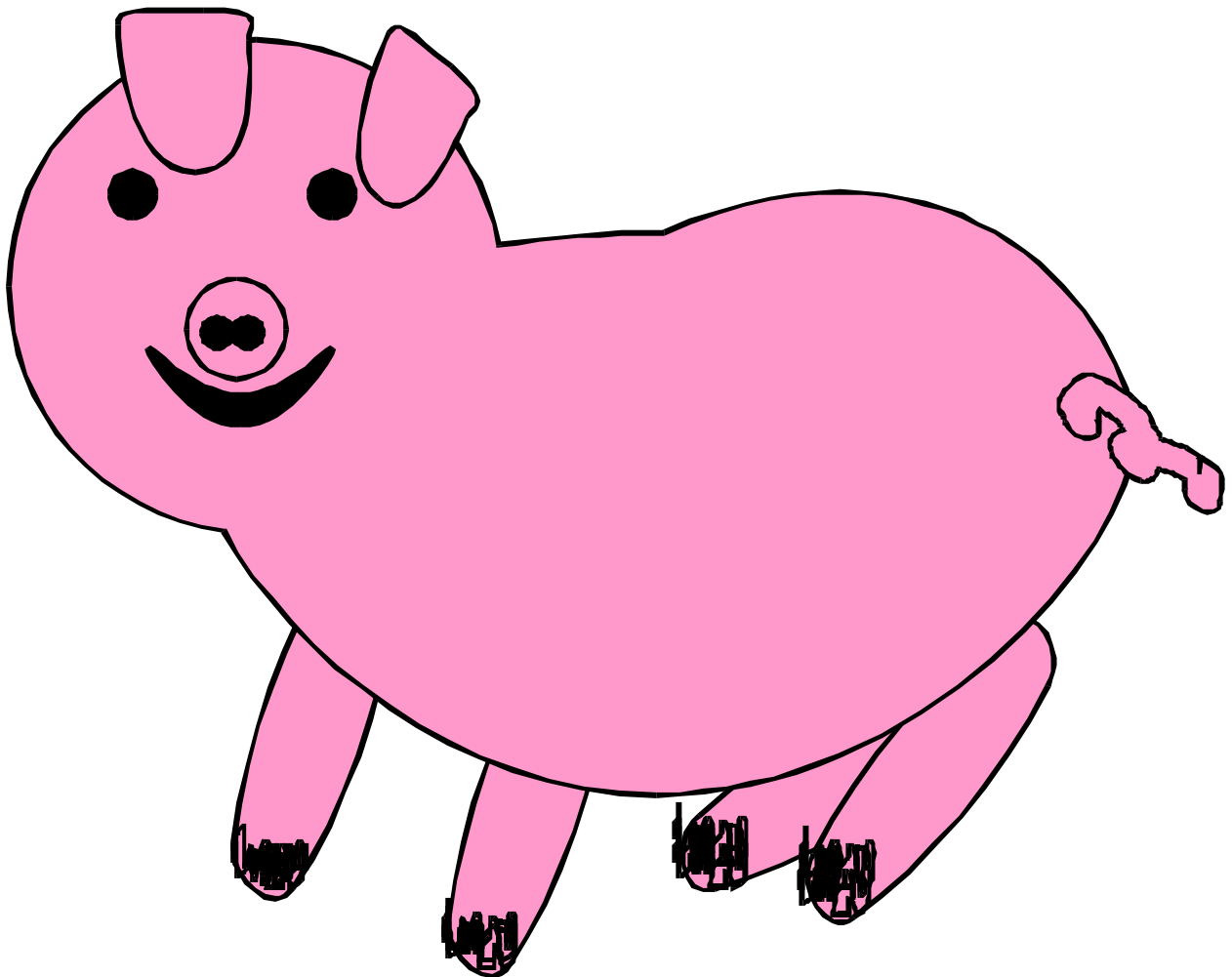
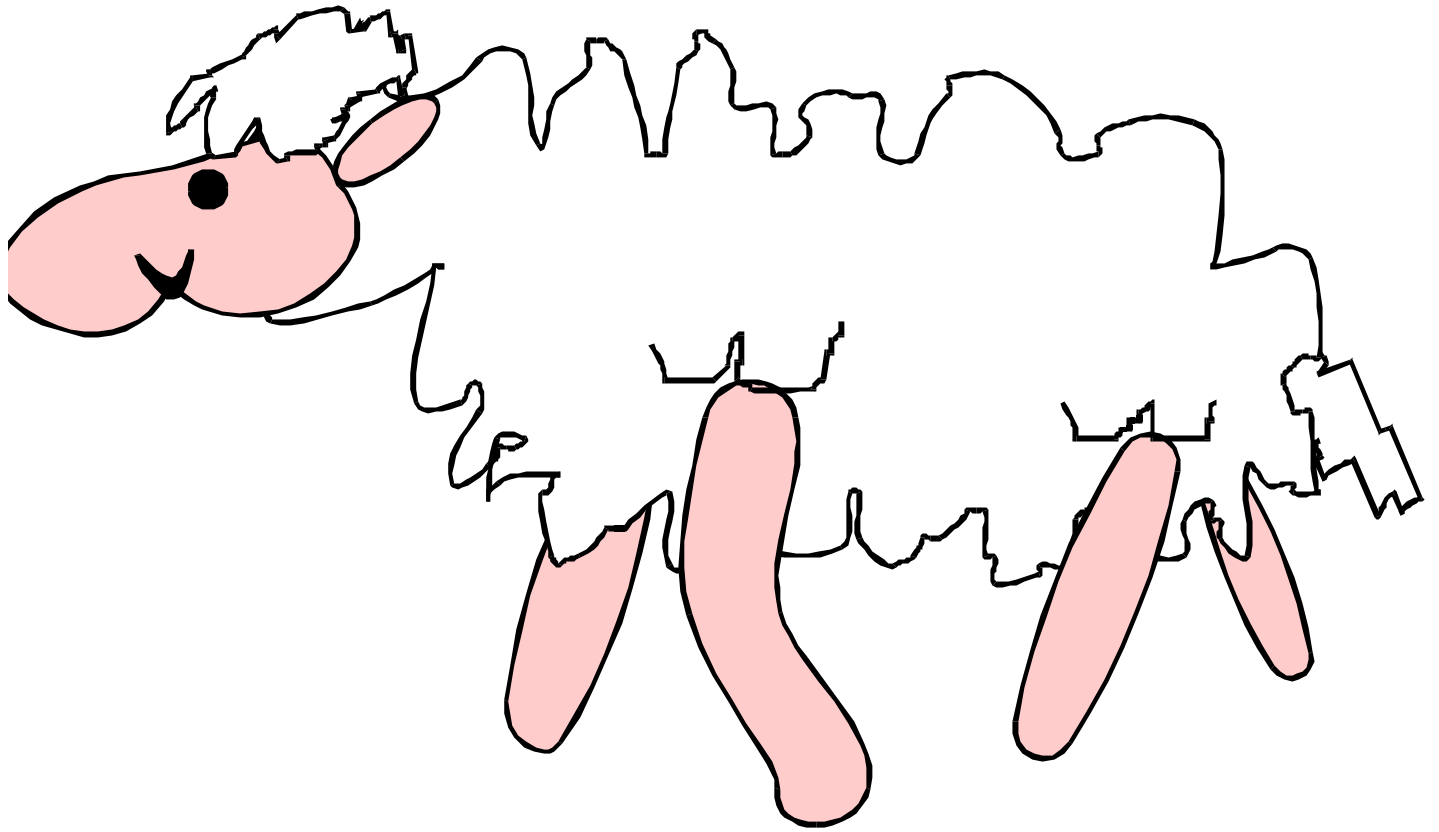

Rellena con algodón el cuerpo del animal cuya piel es suave y de papel pinocho el cuerpo del animal cuya piel es áspera.

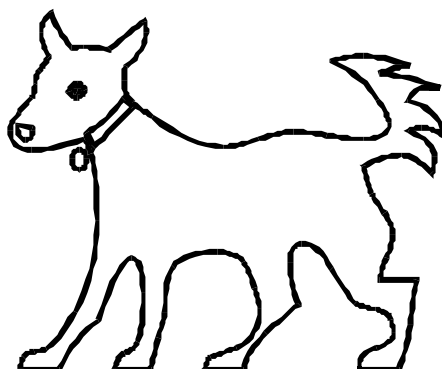
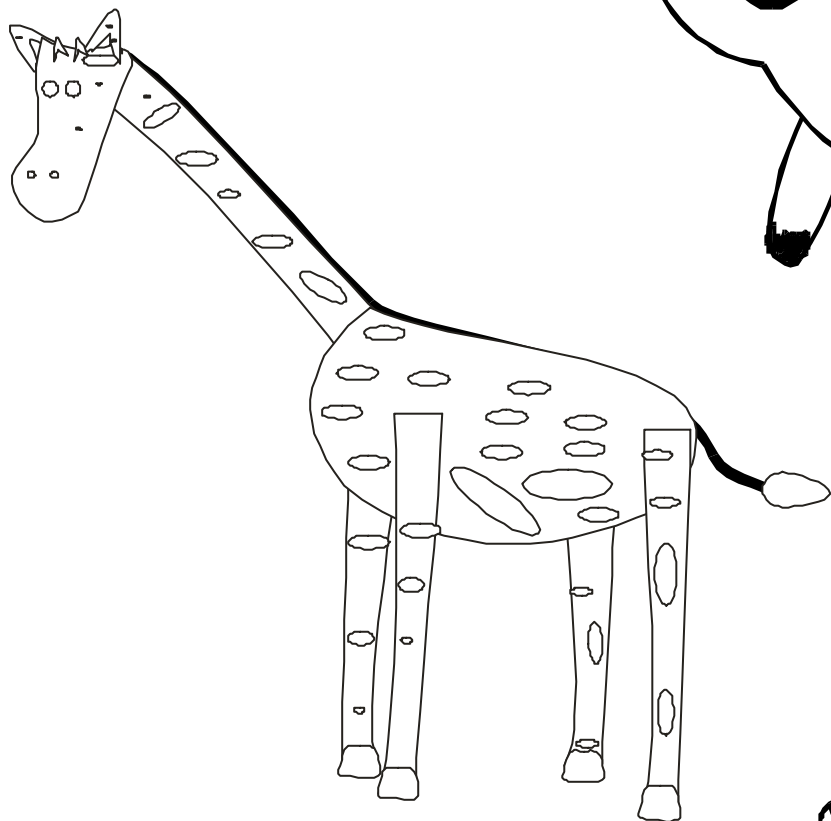
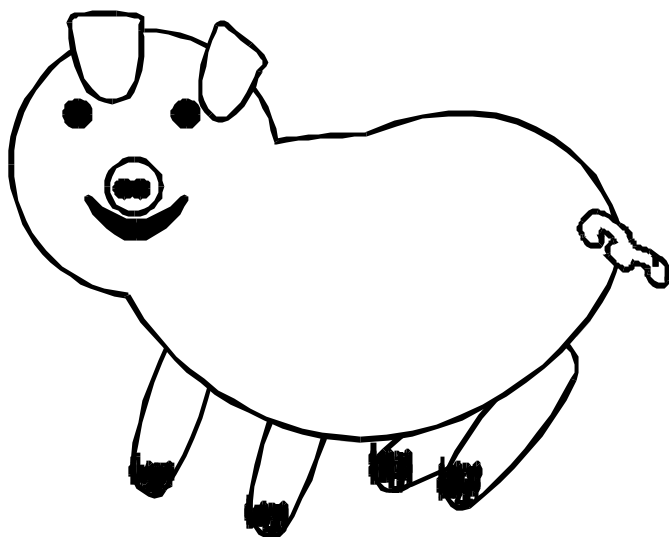
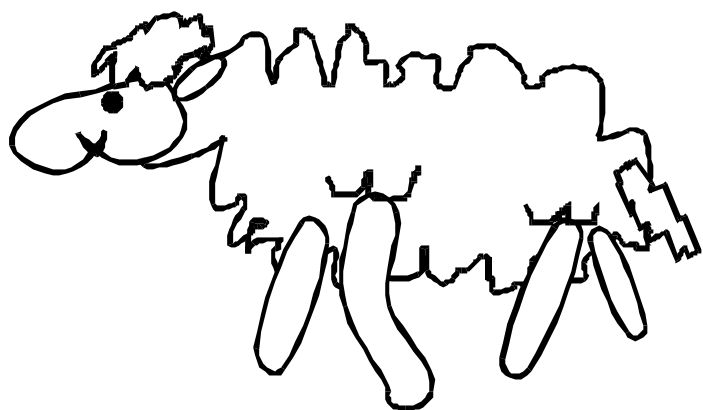

Pinta los animales herbívoros.

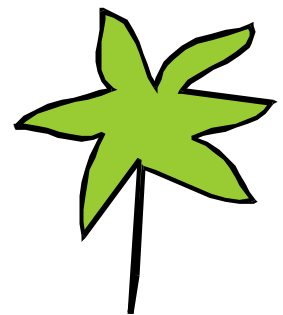
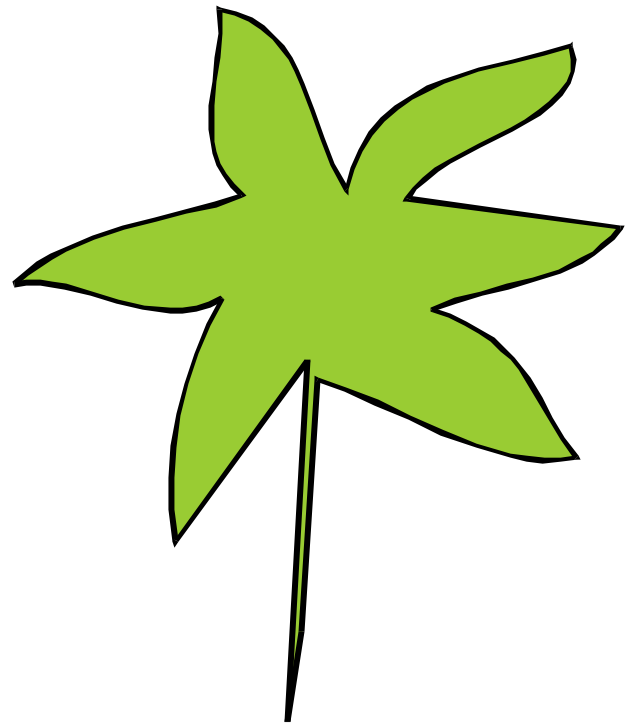
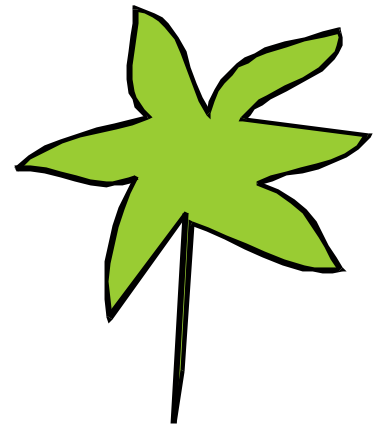

Asocia cada caracol con su hoja.

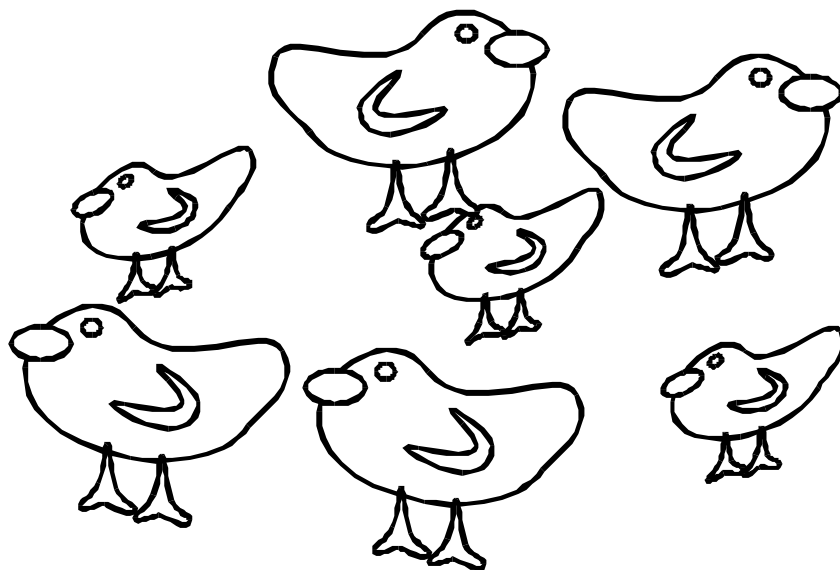
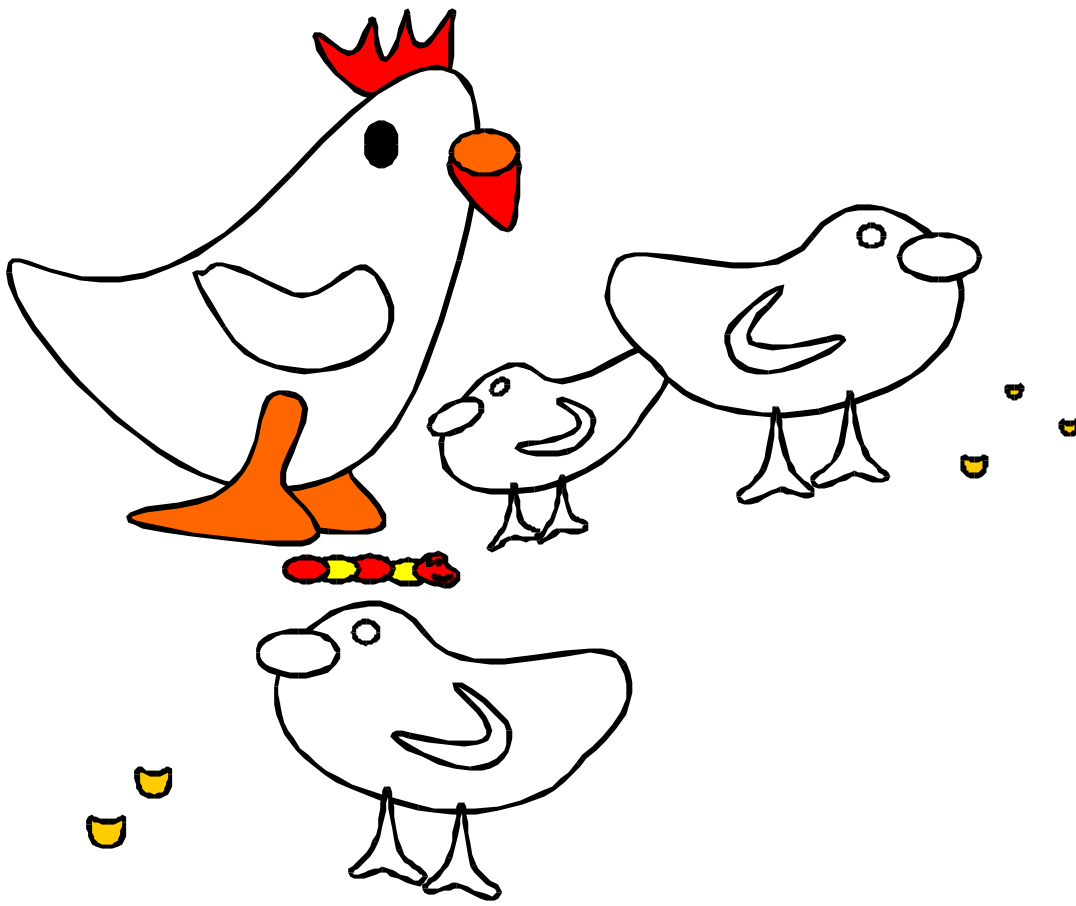

Pinta los pollitos que estás lejos de su mamá.



Pinta el animal que no pertenece al grupo.

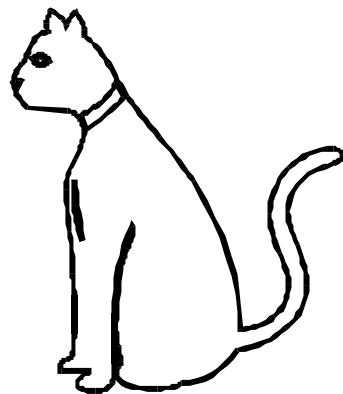
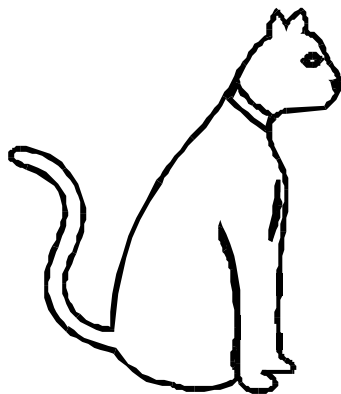
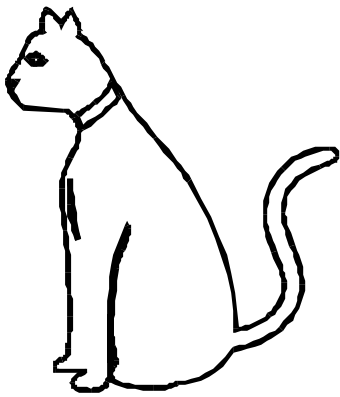
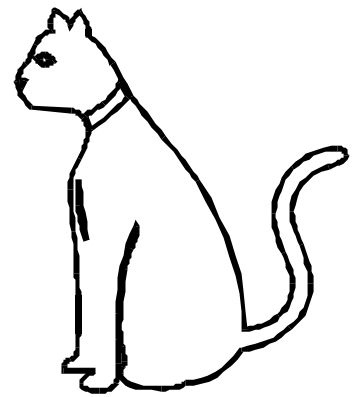
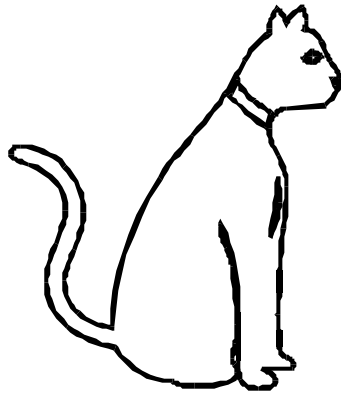
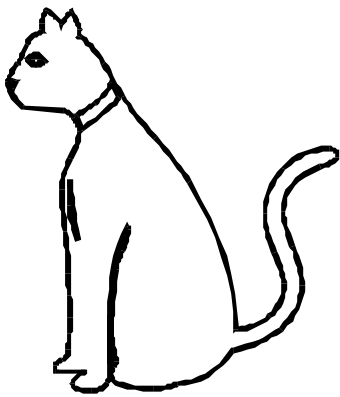
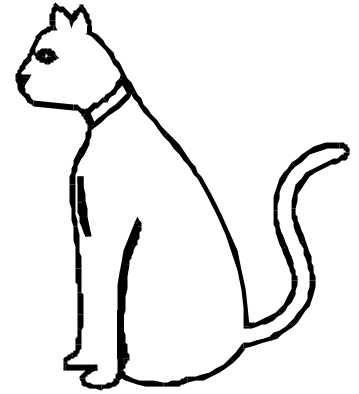
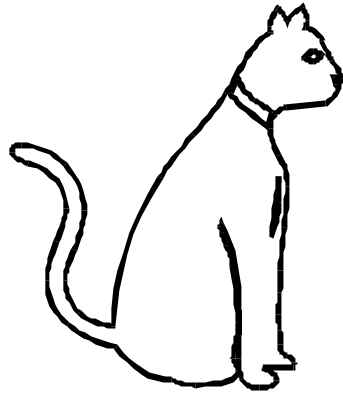
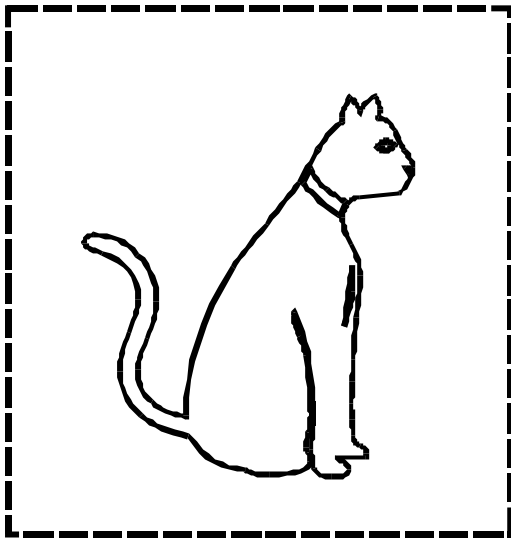

Pinta los gatos que miran hacia la derecha , como el modelo

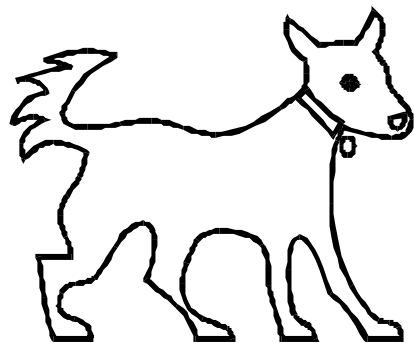
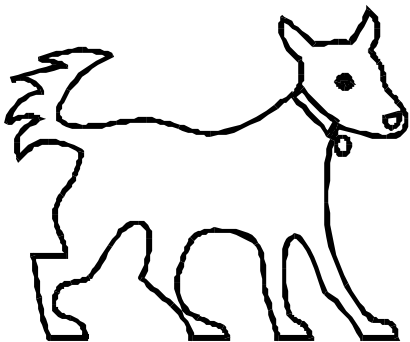
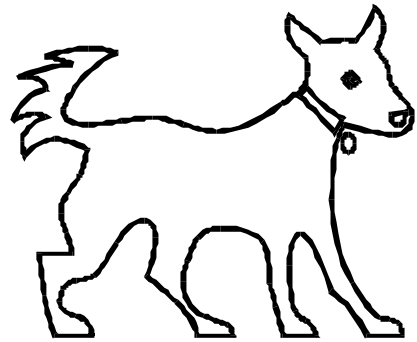
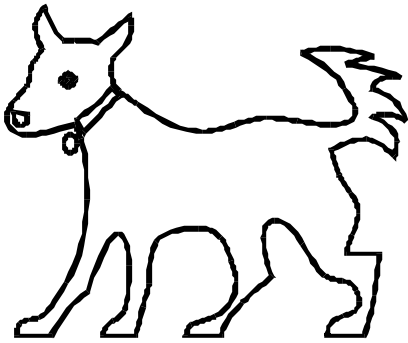
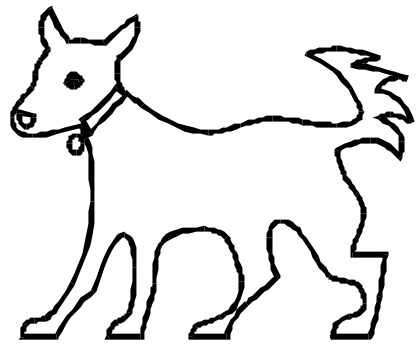
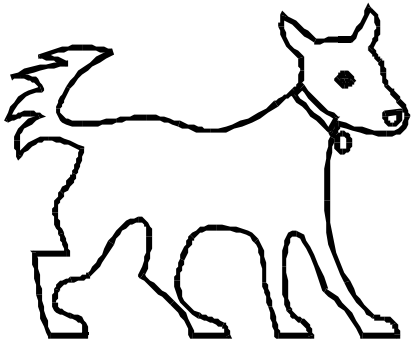
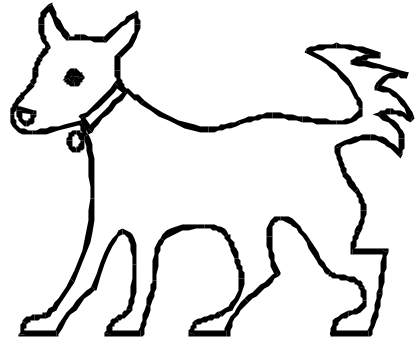
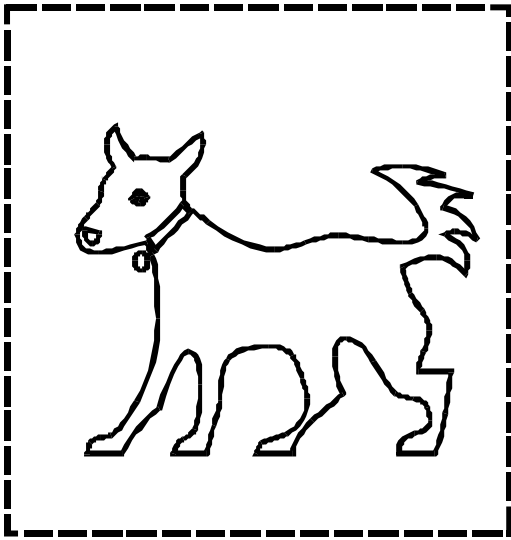

Pinta los perros que miran hacia la izquierda.

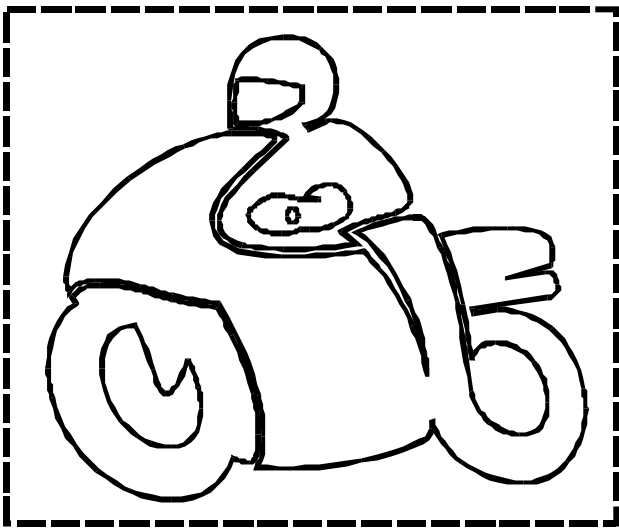

Pica la moto y colócala delante de la casa.

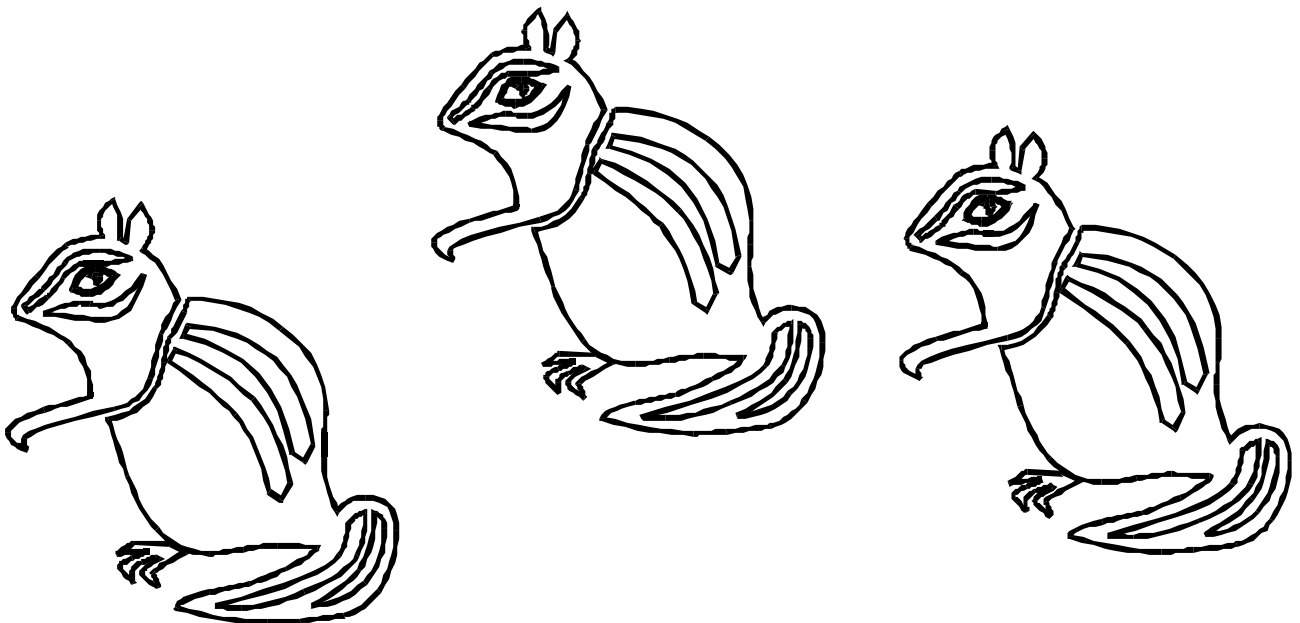
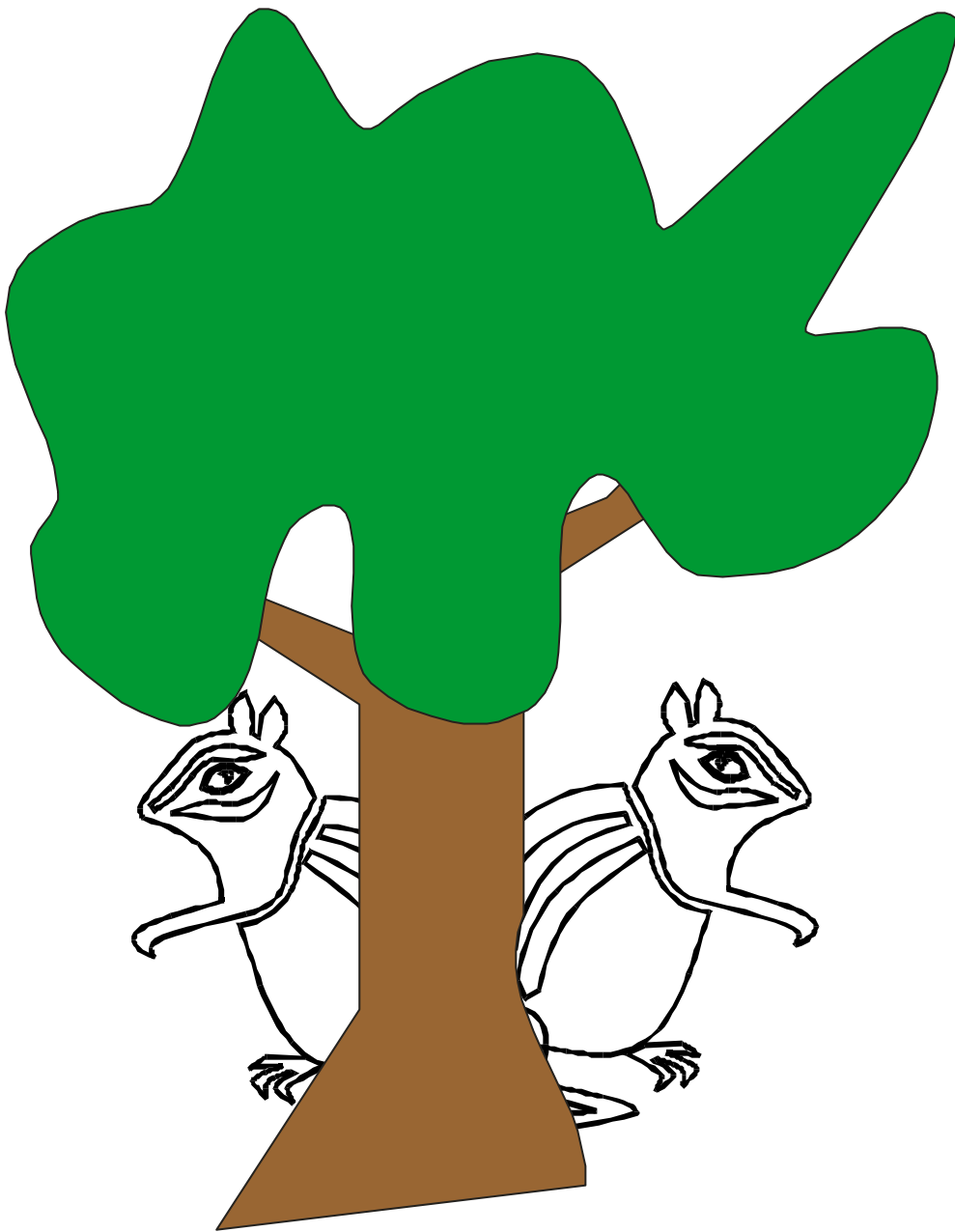

Pinta las ardillas que están detrás del árbol

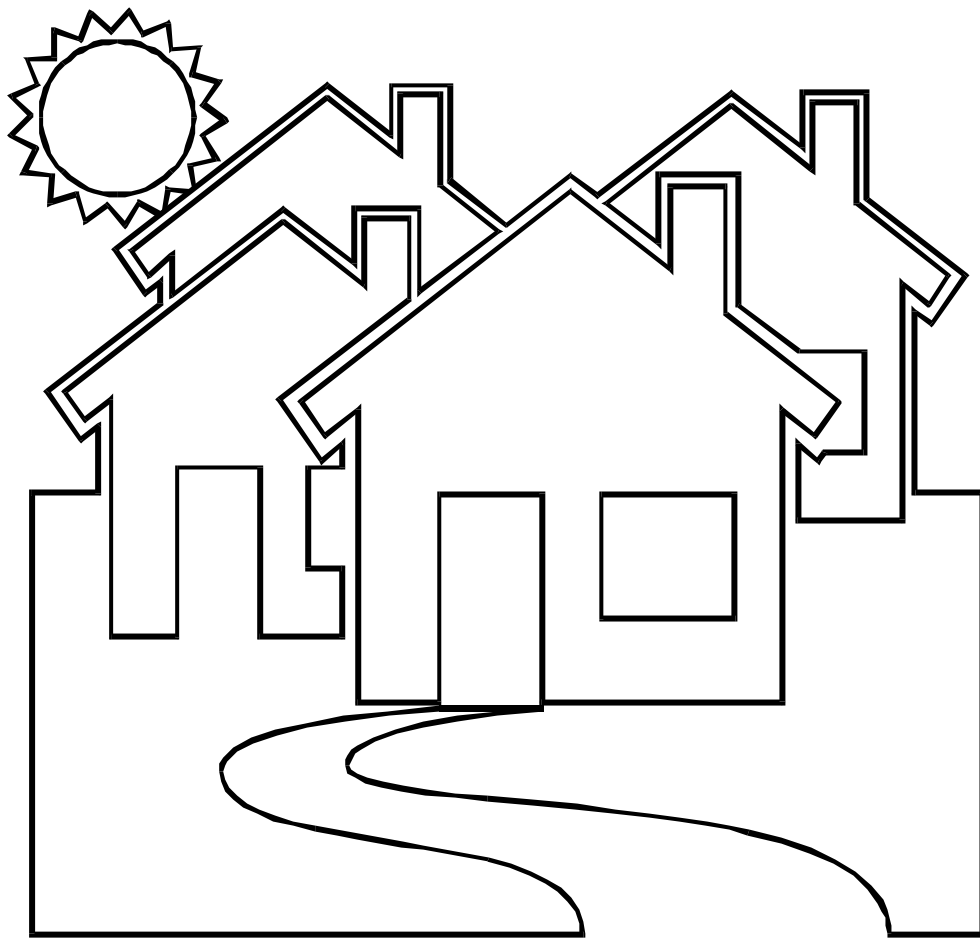

Pinta el pueblo que está de día

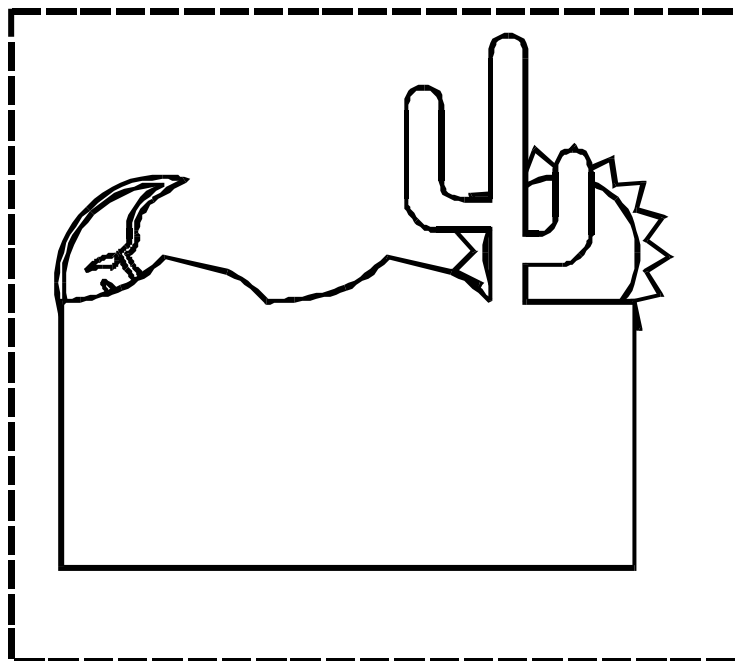
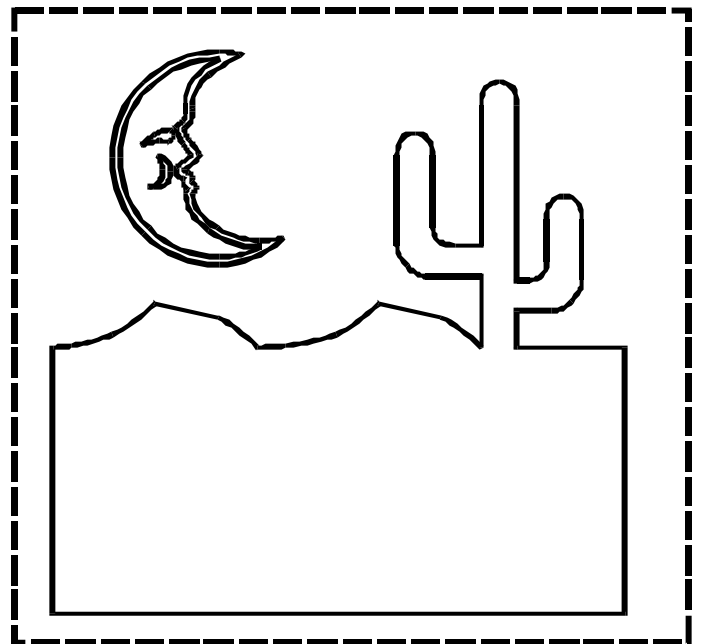
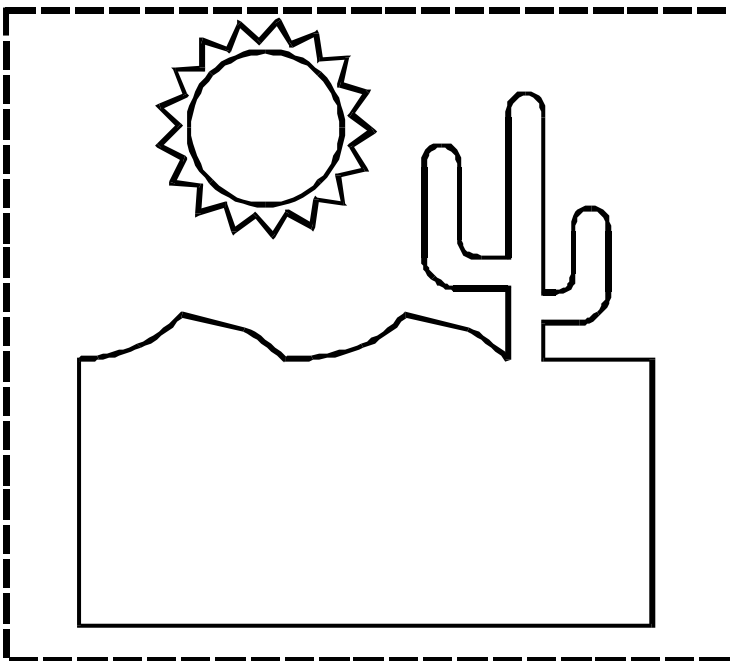
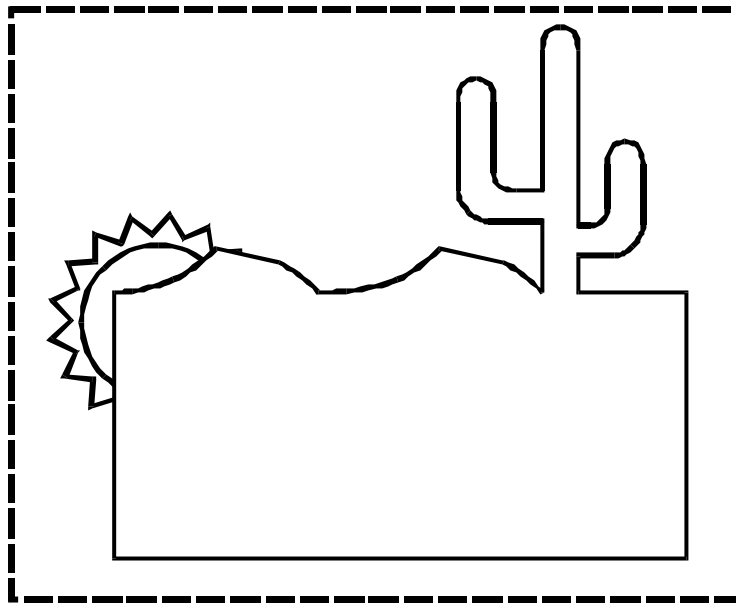

Recorta , pinta y pega en orden.

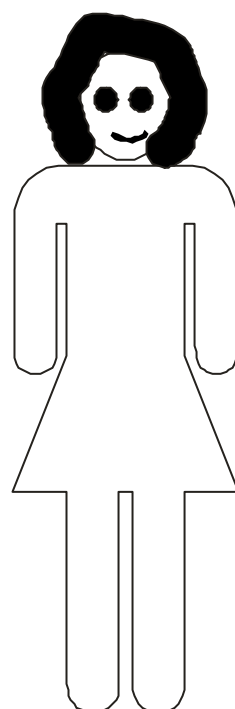
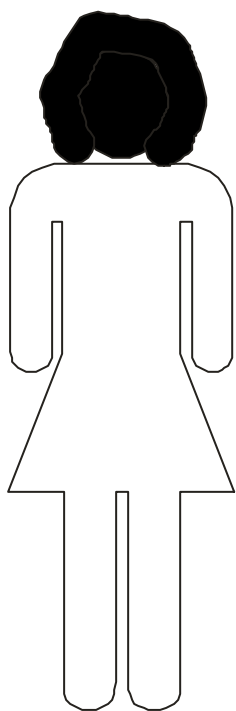
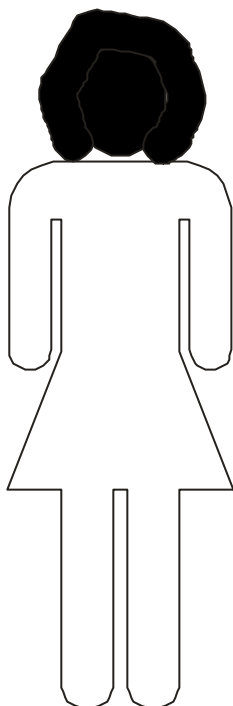
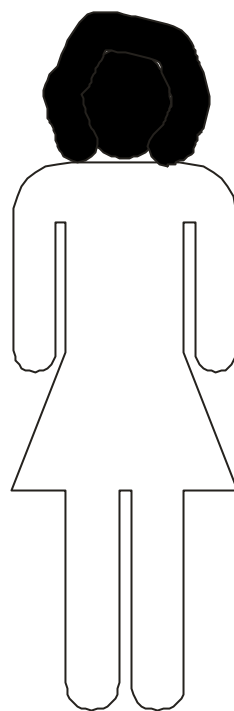
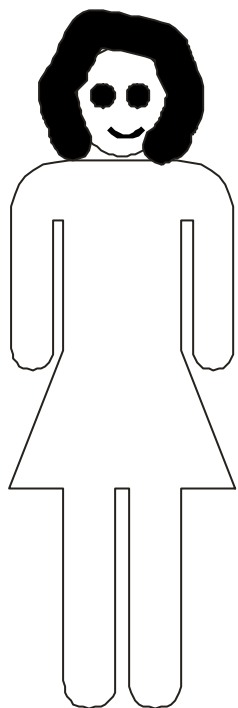

Pintale el vestido a las personas que estén de frente.

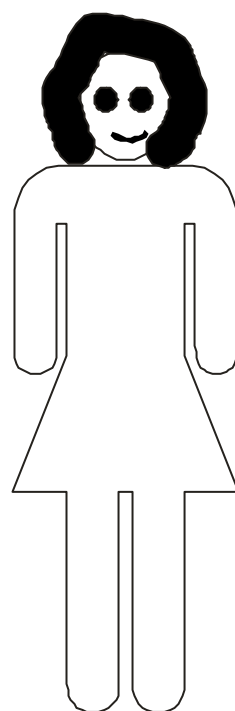
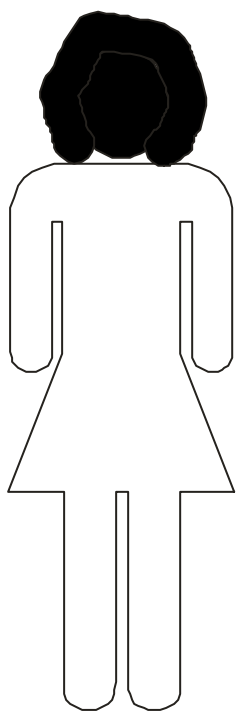
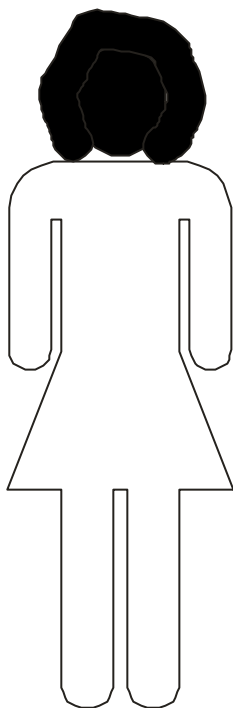
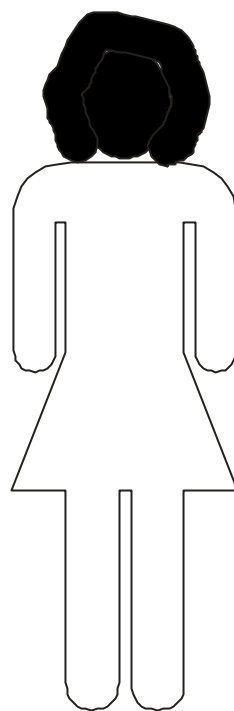
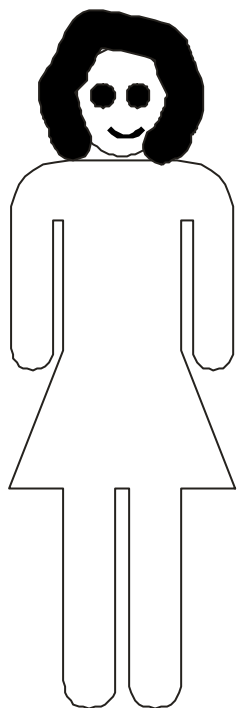

Pintale el vestido a las personas que estén de espaldas.

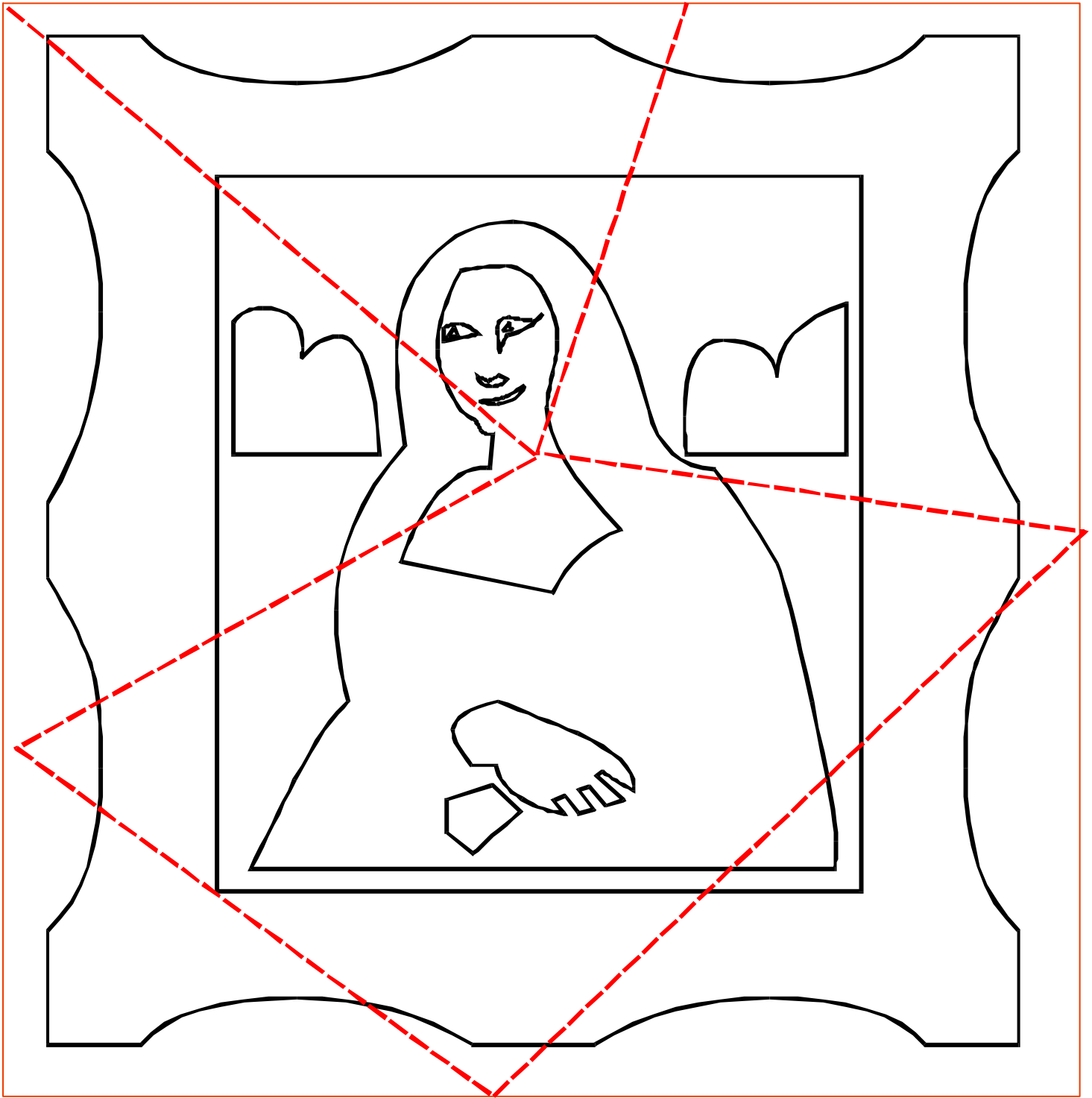

Pinta, recorta por las líneas y reconstruye.

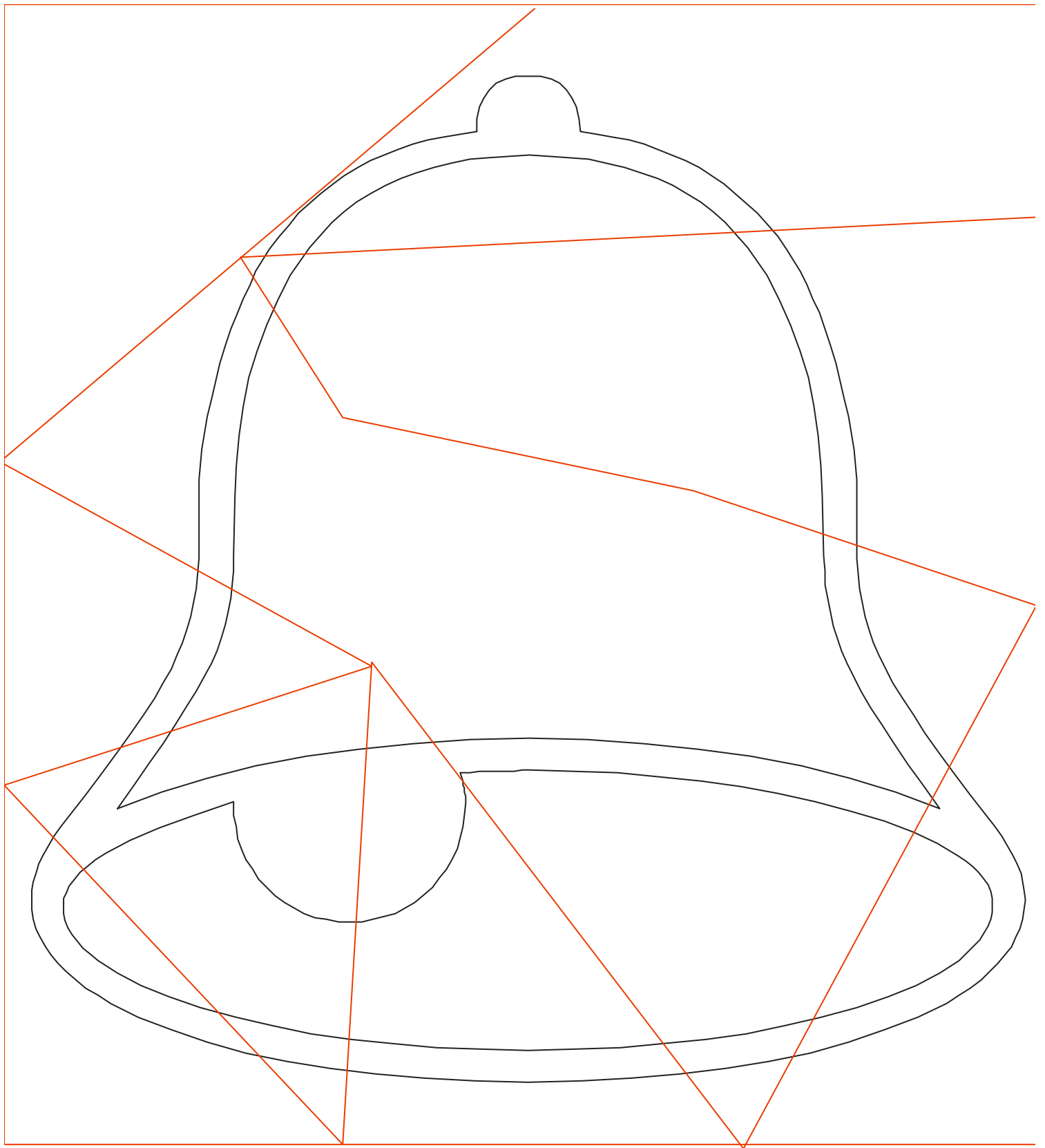

Pinta, recorta por las líneas y reconstruye.

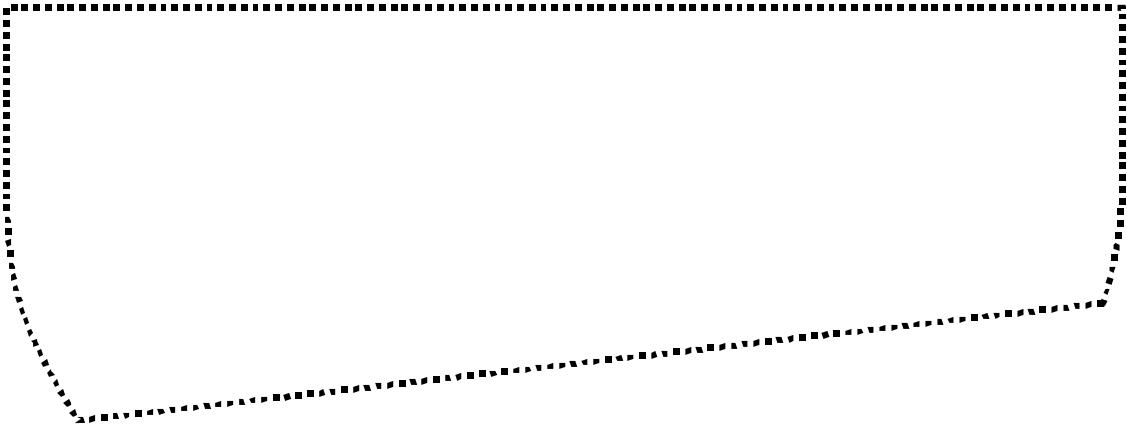
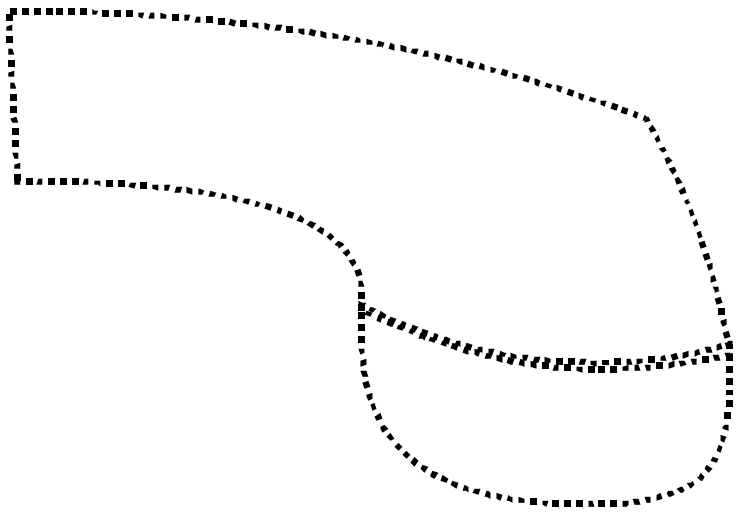
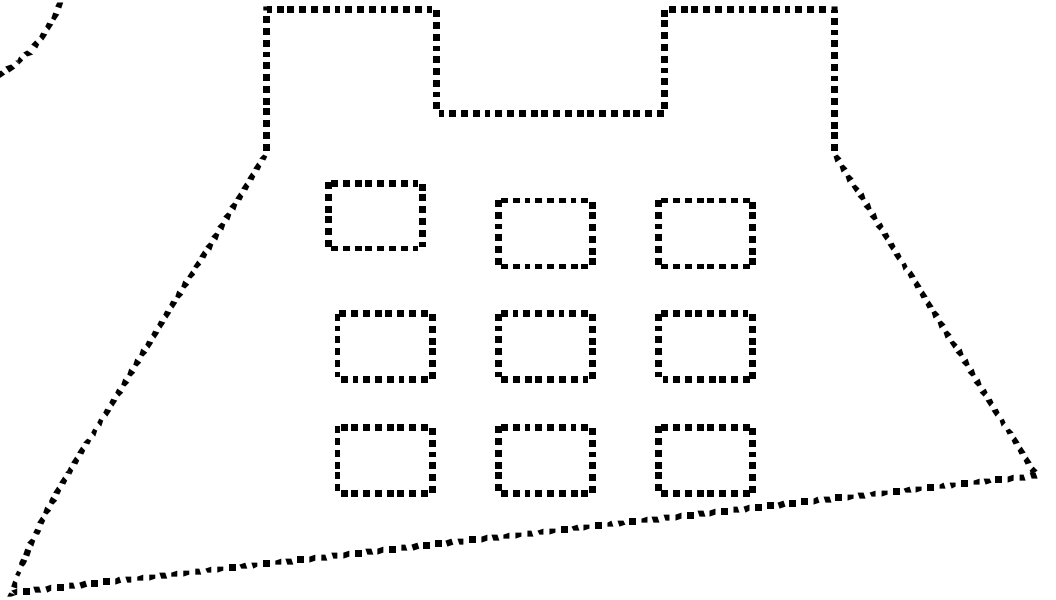

Pica estos elementos y monta.

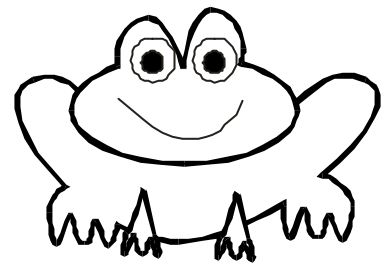
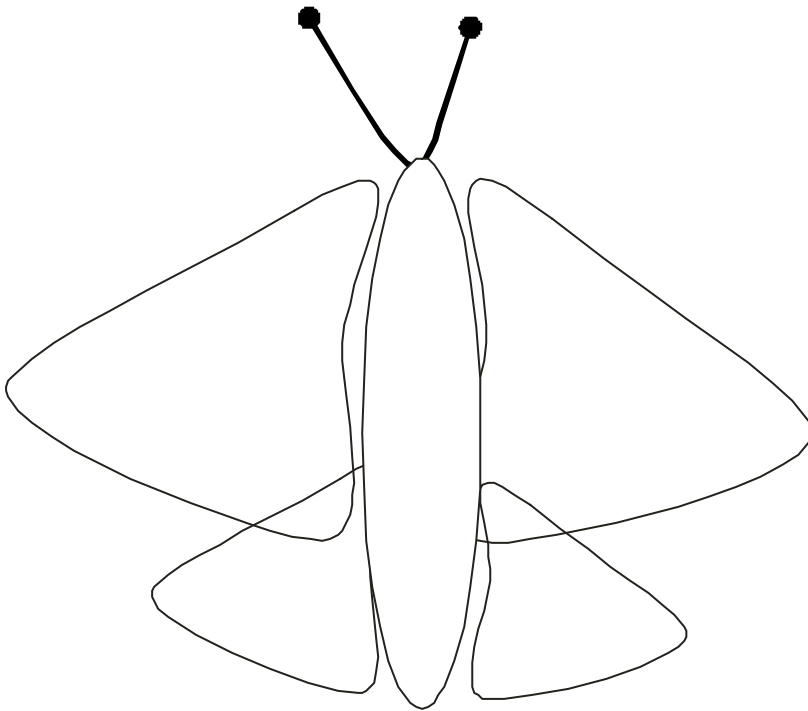
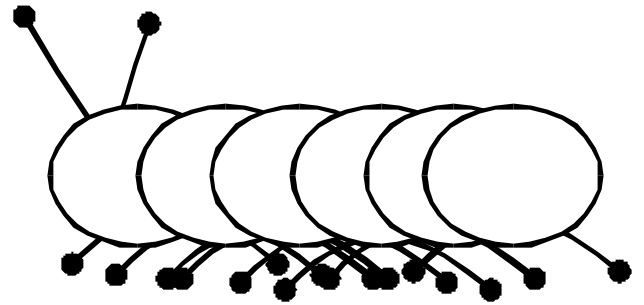
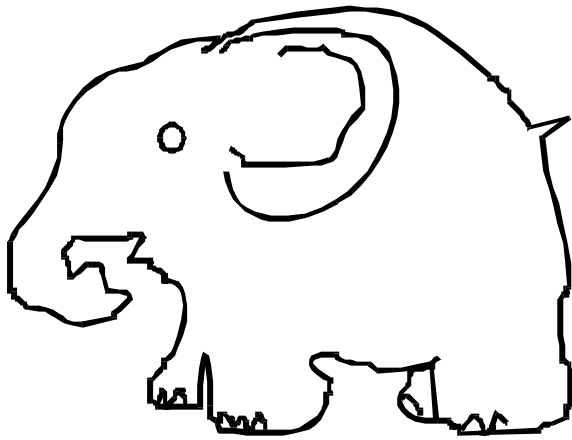
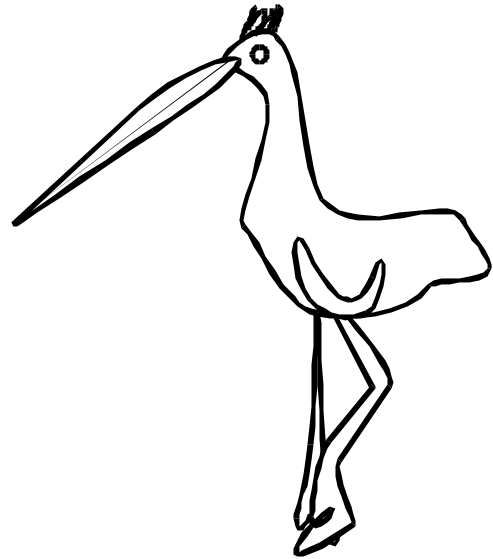
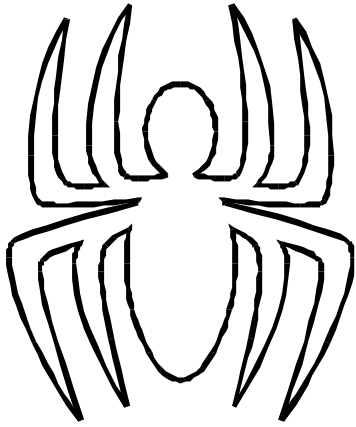

Colorea los animales cuyo cuerpo es blando.

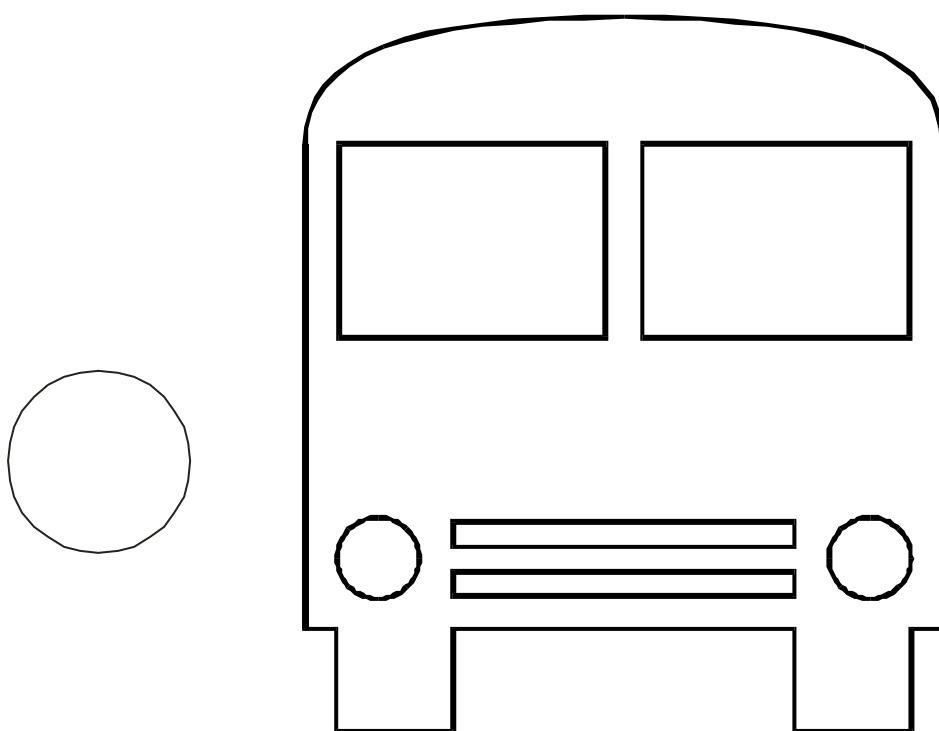
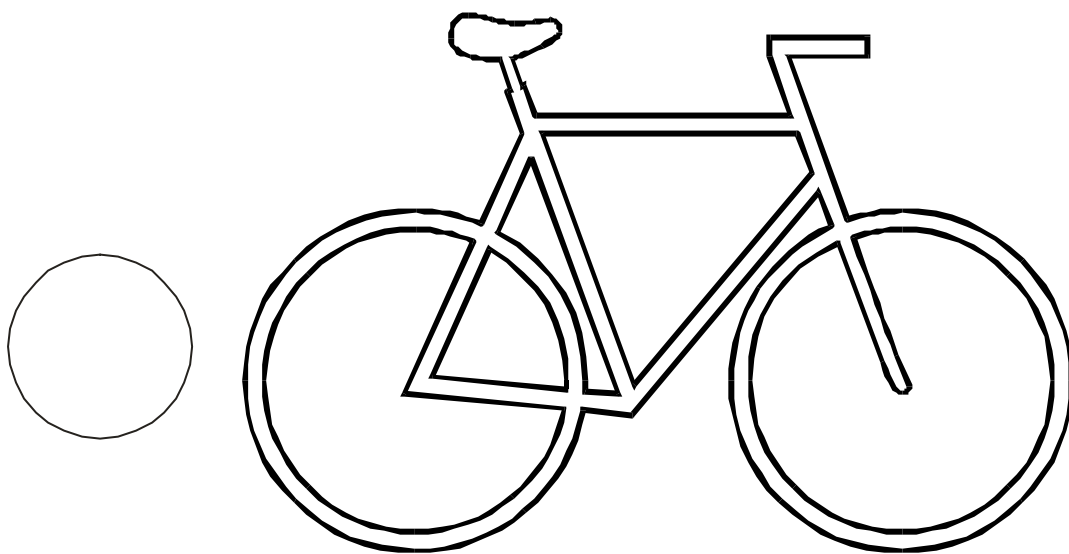
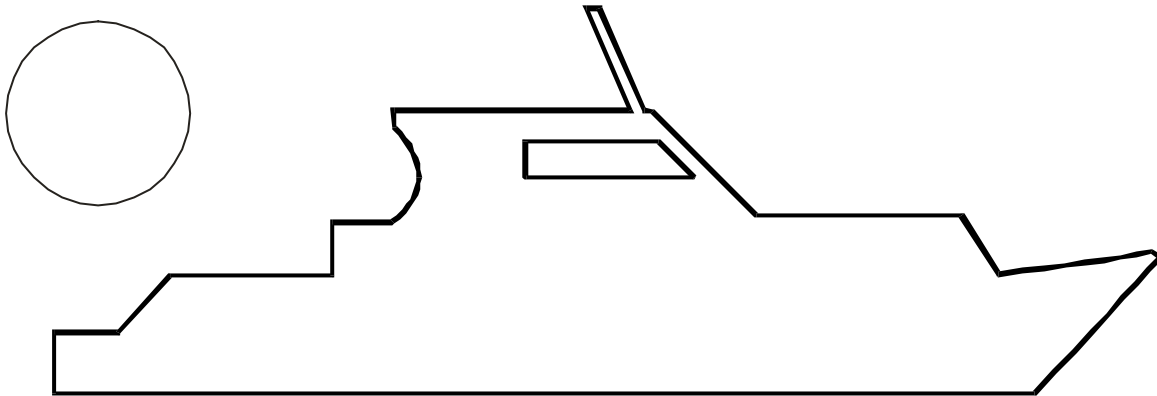

Ordena del más pesado al más ligero y pinta el más ligero.